

Finnigan™
LTQ™

Getting Started

97055-97012 Revision A

Finnigan™, Ion Max™, ZoomScan™, Data Dependent™, Ion Mapping™, and LTQ™ are trademarks and Surveyor® and Xcalibur® are registered trademarks of Thermo Electron Corporation. Microsoft® and Windows® are registered trademarks of Microsoft Corporation. Teflon® is a registered trademark of E.I. du Pont de Nemours & Company. Unimetrics® is a registered trademark of Unimetrics Company. Tygon® is a registered trade mark of Saint-Gobain Performance Plastics Company. Rheodyne® and the Rheodyne logo () are registered trademarks of Rheodyne, L.P.

Technical information contained in this publication is for reference purposes only and is subject to change without notice. Every effort has been made to supply complete and accurate information; however, Thermo Electron Corporation assumes no responsibility and will not be liable for any errors, omissions, damage, or loss that might result from any use of this manual or the information contained therein (even if this information is properly followed and problems still arise).

This publication is not part of the Agreement of Sale between Thermo Electron Corporation and the purchaser of an LC/MS system. In the event of any conflict between the provisions of this document and those contained in Thermo Electron Corporation's Terms and Conditions, the provisions of the Terms and Conditions shall govern.

System Configurations and Specifications supersede all previous information and are subject to change without notice.

Printing History: Revision A printed in July 2003.
Software Version: LTQ 1.0, Xcalibur 1.4

Thermo

ELECTRON CORPORATION

The products of Thermo Electron San Jose are produced under ISO 9001 accredited quality management systems.

Australia: P.O. Box 239 Rydalmere • Unit 14, 38 – 46 South Street • Rydalmere, N.S.W. 2116 • [61] (02) 9898-9000

Austria: Wehlistrasse 27b • A-1200 Wien • [43] (01) 333 50 34-0

Belgium: Technologiestraat 47 • B-1082 Brussels • [32] (02) 482 30 30

Canada: 5716 Coopers Avenue, Unit 1 • Mississauga, Ontario • L4Z 2E8 • [1] (905) 712-2258

France: 16 Avenue du Québec • Silic 765 • Z.A. de Courtaboeuf • F-91963 Les Ulis Cédex • [33] (01) 60 92 48 00

Germany: Im Steingrund 4-6 • D-63303 Dreieich • [49] (06103) 408 0

Italy: Strada Rivoltana • I-20090 Rodano (Milano) • [39] (02) 95059 226

Japan: C-2F • 3-9, Moriya-cho, Kanagawa-ku • Yokohama, Kanagawa • 221-0022 • [81] (45) 453 9100

Japan: Esaka Grand Building • 2-3-1 Esaka-cho, Suita City • Osaka 564-0063 • [81] (06) 6387-6681

Netherlands: Takkebijsters 1 • 4817 BL Breda • [31] (076) 5878 722

P.R. China: Room 901, Ping-an Mansion • No. 23, Jin Rong Street • Xi Cheng District • Beijing 100032 • [86] (010) 6621 0839

Spain: Sepulveda 7 A • ES-28108 Alcobendas (Madrid) • [34] (091) 657 4930

Spain: Acer 30 – 32 • Edificio Sertram – Planta 2, Modulo 3 • ES-08038 Barcelona • [34] (093) 223 0918

Sweden: Pyramidbacken 3 • S-141 75 Kungens Kurva (Stockholm) • [46] (08) 556 468 00

United Kingdom: Stafford House • 1 Boundary Park • Boundary Way • Hemel Hempstead • Hertfordshire HP2 7GE • [44] (01442) 233 555

U.S.A.: 355 River Oaks Parkway • San Jose, CA 95134-1991 • [1] (408) 965-6000

Notes: The country code is enclosed in square brackets []. The city code or area code is enclosed in parenthesis (). For countries other than the U.S.A., when you are dialing from within the specified country, dial the 0 of the city code. For countries other than Italy, when you are dialing from outside the country, do not dial the 0 of the city code.

Thermo

ELECTRON CORPORATION

Customer Registration... Register now and receive all the privileges associated with being a Thermo Electron, Finnigan product user, including application reports and technical reports.

Name _____

Title _____

Company _____

Address _____

City/State/Postal Code _____

Country _____

Telephone _____ Ext. _____

Finnigan LTQ Serial # _____ Date Purchased _____

Tell us more... Let us know more about how you use this product:

My Organization Is: (Check one only)

- Commercial (for profit) lab
- Government lab
- Hospital / Clinic
- Research Institute
- University / College
- Veterinary
- Other _____

Job Function: (Check one only)

- Administration
- Lab Management
- Operator
- Other _____

My Primary Application Is: (Check one only)

- Analytical
- Biomedical
- Clinical / Toxicology
- Energy
- Food / Agriculture
- Forensic / Toxicology
- Pharmaceutical
- Research / Education
- Other _____

Reader Survey... Help us to improve the quality of our documentation by answering a few questions:

<i>Finnigan LTQ Getting Started</i>	<i>Revision A 97055-97012</i>			
	Strongly Agree	Agree	Disagree	Strongly Disagree
The manual is well organized.	1	2	3	4
The manual is clearly written.	1	2	3	4
The manual contains all of the information I need.	1	2	3	4
The instructions are easy to follow.	1	2	3	4
The instructions are complete.	1	2	3	4
The technical information is easy to understand.	1	2	3	4
The figures are helpful.	1	2	3	4
I was able to operate the system by using this manual. (If not, please comment below.)	1	2	3	4

Additional Comments: (Attach additional sheets if necessary.)

Tear this sheet from the manual, fold it closed, stamp it, and drop it in the mail.

From _____



Place
Stamp
Here

← fold

**EDITOR, TECHNICAL PUBLICATIONS
THERMO ELECTRON SAN JOSE
355 RIVER OAKS PARKWAY
SAN JOSE, CA 95134-1991
UNITED STATES OF AMERICA**



← fold

Regulatory Compliance

Thermo Electron San Jose performs complete testing and evaluation of its products to ensure full compliance with applicable domestic and international regulations. When your system is delivered to you, it meets all pertinent electromagnetic compatibility (EMC) and safety standards as follows:

EMC Certification

EN 55011	(1998)	EN 61000-4-4	(1995)
EN 61326	(1998)	EN 61000-4-5	(1995)
EN 61000-4-2	(1998)	EN 61000-4-6	(1996)
EN 61000-4-3	(1996)	EN 61000-4-11	(1994)
ENV 50204	(1995)	FCC Class A	

EMC issues have been evaluated by EMC TECHNOLOGY SERVICES, A Subsidiary of UNDERWRITERS LABORATORY, INC (UL)

Safety Compliance

Low Voltage Directive EN 61010-1:2001

Please be aware that any changes that you make to your system might void compliance with one or more of these EMC and/or safety standards.

Making changes to your system includes replacing a part. Thus, to ensure continued compliance with EMC and safety standards, replacement parts should be ordered from Thermo Electron or one of its authorized representatives.

FCC Compliance Statement

Note: This equipment has been tested and found to comply with the limits for a Class A digital device, pursuant to part 15 of the FCC rules. These limits are designed to provide reasonable protection against harmful interference when the equipment is operated in a commercial environment. This equipment generates, uses, and can radiate radio frequency energy. If it is not installed and used in accordance with the instruction manual, it might cause harmful interference to radio communications. Operation of this equipment in a residential area is likely to cause harmful interference. In this case, the user will be required to correct the interference at his/her own expense.

**Notice on Lifting and Handling of
Thermo Electron San Jose Instruments**

For your safety, and in compliance with international regulations, the physical handling of this Thermo Electron San Jose instrument *requires a team effort* for lifting and/or moving the instrument. This instrument is too heavy and/or bulky for one person alone to handle safely.

**Notice on the Proper Use of
Thermo Electron San Jose Instruments**

In compliance with international regulations: If this instrument is used in a manner not specified by Thermo Electron San Jose, the protection provided by the instrument could be impaired.

Contents

Read This Firstv

Changes to the Manual and Online Help vi

Abbreviations vii

Typographical Conventions xi

 Data Input xi

 Boxed Information..... xii

 Topic Headings..... xiii

Reply Cards xiv

Introduction 1-1

1.1 Why Use the Finnigan LTQ MS Detector?..... 1-2

1.2 Which MS Detector Technique—ESI or APCI—Is Better for Analyzing My Samples? 1-4

 Using ESI/MS..... 1-4

 Using APCI/MS..... 1-5

1.3 Should I Use Sheath, Auxiliary, and/or Sweep Gases?..... 1-7

1.4 How Can I Introduce My Samples into the MS Detector? 1-8

1.5 What Types of Buffers Should I Use? What Types Should I Avoid? 1-10

1.6 How Should I Set Up the MS Detector for Various LC Flow Rates? 1-11

1.7 What is Tuning and Calibration of the MS Detector All About? 1-13

1.8 What Types of Experiments Can I Perform with the Finnigan LTQ MS Detector? 1-16

 General MS or MSⁿ Experiments..... 1-16

 Data-Dependent Experiments..... 1-18

 Ion Mapping Experiments 1-20

 Ion Tree Experiments 1-22

Setting Up the Ion Source for Tuning and Calibrating the MS Detector 2-1

2.1 Placing the LC/MS System in Standby 2-2

2.2 Removing the APCI Probe..... 2-3

2.3 Removing the Ion Max Ion Source Housing 2-6

2.4 Installing the Ion Sweep Cone 2-7

2.5	Installing the Ion Max Ion Source Housing.....	2-9
2.6	Installing the ESI Probe.....	2-12
Tuning and Calibrating Automatically in the ESI/MS Mode		3-1
3.1	Setting Up the Syringe Pump for Tuning and Calibration	3-2
3.2	Setting Up the MS Detector in the Xcalibur Data System for Tuning and Calibration	3-4
3.3	Testing the Operation of the MS Detector in the ESI/MS Mode.....	3-9
3.4	Tuning the MS Detector Automatically in the ESI/MS Mode	3-13
3.5	Saving Your ESI/MS Tune Method.....	3-17
3.6	Calibrating the MS Detector Automatically.....	3-19
3.7	Cleaning the MS Detector after Tuning and Calibrating.....	3-22
Tuning with Your Analyte in LC/ESI/MS Mode		4-1
4.1	Setting Up to Introduce Sample by Syringe Pump into Solvent Flow from an LC	4-3
4.2	Setting Up to Tune the MS Detector with Your Analyte.....	4-6
4.3	Optimizing the MS Detector Tune Automatically with Your Analyte	4-9
4.4	Saving the ESI/MS Tune Method.....	4-12
Acquiring ESI Sample Data Using the Tune Plus Window		5-1
5.1	Setting Up to Acquire MS/MS Data in the Full Scan Type.....	5-2
	Optimizing the Isolation Width and Setting Up to Optimize the Collision Energy.....	5-2
	Optimizing the Collision Energy Automatically for an MS/MS Experiment.....	5-8
5.2	Setting Up to Introduce Sample by Loop Injection into Solvent Flow from an LC.....	5-10
5.3	Acquiring MS Data in the SIM Scan Type.....	5-12
Setting Up the Ion Source for Acquiring Data in APCI/MS/MS Mode		6-1
6.1	Removing the ESI Probe	6-2
6.2	Removing the Ion Max Ion Source Housing	6-4
6.3	Removing the Ion Sweep Cone	6-5
6.4	Installing the Corona Needle	6-6

Finnigan LTQ

6.5	Installing the Ion Max Ion Source Housing	6-7
6.6	Installing the APCI Probe	6-10
Optimizing the MS Detector with Your Analyte in APCI/MS Mode		7-1
7.1	Setting Up the Inlet for Tuning Using High-Flow Infusion.....	7-2
7.2	Setting Up the MS Detector for APCI/MS Operation	7-5
7.3	Optimizing the Tune of the MS Detector Automatically in APCI/MS Mode	7-8
7.4	Saving the APCI/MS Tune Method	7-11
7.5	Cleaning the MS Detector after Tuning in APCI Mode	7-13
Acquiring APCI Sample Data Using the Tune Plus Window		8-1
8.1	Setting Up to Introduce Sample by Loop Injection into Solvent Flow from an LC	8-2
8.2	Acquiring APCI Data in the SIM Scan Mode.....	8-4
Sample Formulations		A-1
A.1	Caffeine, MRFA, and Ultramark 1621 Stock Solutions.....	A-2
	Stock Solution: Caffeine.....	A-2
	Stock Solution: MRFA	A-2
	Stock Solution: Ultramark 1621	A-3
A.2	ESI Calibration Solution: Caffeine, MRFA, Ultramark 1621	A-4
A.3	Reserpine.....	A-5
	Stock Solution: Reserpine	A-5
	ESI / APCI Sample Solution: Reserpine	A-5

Read This First

Welcome to the Thermo Electron, Finnigan™ LTQ™ system! The LTQ is a member of the Finnigan family of MS detectors.

This **Finnigan LTQ Getting Started** manual provides you with information on how to set up, calibrate, and tune the Finnigan LTQ MS detector, and how to acquire LC/MS data. All of these procedures can be performed from the Xcalibur® Tune Plus window.

Finnigan LTQ Getting Started includes the following chapters:

Chapter 1: Introduction answers typical questions about the Finnigan LTQ MS detector and lists LC/MS instrument parameters for typical analyses.

Chapter 2: Setting Up the Ion Source for Tuning and Calibrating the MS Detector provides instructions to set up the ESI probe assembly.

Chapter 3: Tuning and Calibrating Automatically in the ESI/MS Mode provides procedures to tune and calibrate your Finnigan LTQ MS detector using calibration solution.

Chapter 4: Tuning with Your Analyte in LC/ESI/MS Mode describes how to optimize the Finnigan LTQ MS detector in ESI mode using your compound of interest.

Chapter 5: Acquiring ESI Sample Data Using the Tune Plus Window describes how to set up the Finnigan LTQ MS detector for acquiring MS/MS data, and then describes a simple procedure for acquiring ESI sample data on your Finnigan LTQ system.

Chapter 6: Setting Up the Ion Source for Acquiring Data in APCI/MS/MS Mode gives instructions to set up the APCI probe assembly.

Chapter 7: Optimizing the MS Detector with Your Analyte in APCI/MS Mode describes how to optimize the Finnigan LTQ MS detector in APCI mode using your compound of interest.

Chapter 8: Acquiring APCI Sample Data Using the Tune Plus Window describes a simple procedure for acquiring APCI sample data on your Finnigan LTQ system.

Appendix A: Sample Formulations gives instructions about preparing solutions you can use to acquire data with your Finnigan LTQ MS detector.

If you want to perform analyses in ESI mode, read Chapters 2, 3, 4, and 5. If you want to perform analyses in APCI mode, go to Chapters 2, 3, 6, 7, and 8.

Changes to the Manual and Online Help

To suggest changes to this manual or the online Help, please send your comments to:

Editor, Technical Publications
Thermo Electron San Jose
355 River Oaks Parkway
San Jose, CA 95134-1991
U.S.A.

You are encouraged to report errors or omissions in the text or index.
Thank you.

Abbreviations

The following abbreviations are used in this and other manuals and in the online Help.

A	ampere
ac	alternating current
ADC	analog-to-digital converter
AP	acquisition processor
APCI	atmospheric pressure chemical ionization
API	atmospheric pressure ionization
ASCII	American Standard Code for Information Interchange
b	bit
B	byte (8 b)
baud rate	data transmission speed in events per second
°C	degrees Celsius
CD	compact disc
CD-ROM	compact disc read-only memory
cfm	cubic feet per minute
CI	chemical ionization
CIP	carriage and insurance paid to
cm	centimeter
cm ³	cubic centimeter
CPU	central processing unit (of a computer)
CRC	cyclic redundancy check
CRM	consecutive reaction monitoring
<Ctrl>	control key on the terminal keyboard
<i>d</i>	depth
Da	dalton
DAC	digital-to-analog converter
dc	direct current
DDS	direct digital synthesizer
DEP™	direct exposure probe
DS	data system
DSP	digital signal processor

EI	electron ionization
EMBL	European Molecular Biology Laboratory
<Enter>	enter key on the terminal keyboard
ESD	electrostatic discharge
ESI	electrospray ionization
eV	electron volt
f	femto (10^{-15})
°F	degrees Fahrenheit
.fasta file	extension of a SEQUEST search database file
FOB	free on board
ft	foot
FTP	file transfer protocol
g	gram
G	giga (10^9)
GC	gas chromatograph; gas chromatography
GC/MS	gas chromatograph / MS detector
GND	electrical ground
GPIB	general-purpose interface bus
GUI	graphical user interface
h	hour
<i>h</i>	height
HPLC	high-performance liquid chromatograph
HV	high voltage
Hz	hertz (cycles per second)
ICIS™	Interactive Chemical Information System
ICL™	Instrument Control Language™
ID	inside diameter
IEC	International Electrotechnical Commission
IEEE	Institute of Electrical and Electronics Engineers
in.	inch
I/O	input/output
k	kilo (10^3 , 1000)
K	kilo (2^{10} , 1024)
KEGG	Kyoto Encyclopedia of Genes and Genomes
kg	kilogram

<i>l</i>	length
L	liter
LAN	local area network
lb	pound
LC	liquid chromatograph; liquid chromatography
LC/MS	liquid chromatograph / mass spectrometer
LED	light-emitting diode
μ	micro (10 ⁻⁶)
m	meter
m	milli (10 ⁻³)
M	mega (10 ⁶)
M+	molecular ion
MB	Megabyte (1 048 576 bytes)
MH+	protonated molecular ion
min	minute
mL	milliliter
mm	millimeter
MS	mass spectrometer; mass spectrometry
MS	MS ⁿ power: where n = 1
MS/MS	MS ⁿ power: where n = 2
MS ⁿ	MS ⁿ power: where n = 1 through 10
<i>m/z</i>	mass-to-charge ratio
n	nano (10 ⁻⁹)
NCBI	National Center for Biotechnology Information (USA)
NIST	National Institute of Standards and Technology (USA)
OD	outside diameter
Ω	ohm
p	pico (10 ⁻¹²)
Pa	pascal
PCB	printed circuit board
PID	proportional / integral / differential
P/N	part number
P/P	peak-to-peak voltage

ppm	parts per million
psig	pounds per square inch, gauge
RAM	random access memory
RF	radio frequency
RMS	root mean square
ROM	read-only memory
RS-232	industry standard for serial communications
s	second
SIM	selected ion monitoring
solids probe	direct insertion probe
SRM	selected reaction monitoring
SSQ [®]	single stage quadrupole
TCP/IP	transmission control protocol / Internet protocol
TIC	total ion current
Torr	torr
TSQ [®]	triple stage quadrupole
u	atomic mass unit
URL	uniform resource locator
V	volt
V ac	volts alternating current
V dc	volts direct current
vol	volume
w	width
W	watt
WWW	World Wide Web

Note. Exponents are written as superscripts. In the corresponding online Help, exponents are sometimes written with a caret (^) or with *e* notation because of design constraints in the online Help. For example:

MSⁿ (in this manual) MS^n (in the online Help)

10⁵ (in this manual) 10^5 (in the online Help)

Typographical Conventions

Typographical conventions have been established for Thermo Electron San Jose manuals for the following:

- Data input
- Boxed information
- Topic headings

Data Input

Throughout this manual, the following conventions indicate data input and output via the computer:

- Messages displayed on the screen are represented by capitalizing the initial letter of each word and by italicizing each word.
- Input that you enter by keyboard is represented in **bold face letters**. (Titles of topics, chapters, and manuals also appear in bold face letters.)
- For brevity, expressions such as “choose **File > Directories**” are used rather than “pull down the File menu and choose Directories.”
- Any command enclosed in angle brackets < > represents a single keystroke. For example, “press <F1>” means press the key labeled *F1*.
- Any command that requires pressing two or more keys simultaneously is shown with a plus sign connecting the keys. For example, “press <Shift> + <F1>” means press and hold the <Shift> key and then press the <F1> key.
- Any button that you click on the screen is represented in bold face letters and a different font. For example, “click on **Close**”.

Boxed Information

Information that is important, but not part of the main flow of text, is displayed in a box such as the one below.

Note. Boxes such as this are used to display information.

Boxed information can be of the following types:

- **Note** – information that can affect the quality of your data. In addition, notes often contain information that you might need if you are having trouble.
- **Tip** – helpful information that can make a task easier.
- **Important** – critical information that can affect the quality of your data.
- **Caution** – information necessary to protect your instrument from damage.
- **CAUTION** – hazards to human beings. Each CAUTION is accompanied by a CAUTION symbol. Each hardware manual has a blue CAUTION sheet that lists the CAUTION symbols and their meanings.
- **DANGER** – laser-related hazards to human beings. It includes information specific to the class of laser involved. Each DANGER is accompanied by the international laser radiation symbol.

Topic Headings

The following headings are used to show the organization of topics within a chapter:

Chapter 1

Chapter Name

1.2 Second Level Topics

Third Level Topics

Fourth Level Topics

Fifth Level Topics

Reply Cards

Thermo Electron San Jose manuals contain one or two reply cards. All manuals contain a Customer Registration / Reader Survey card and some contain a Change of Location card. These cards are located at the front of each manual.

The Customer Registration / Reader Survey card has two functions. First, when you return the card, you are placed on the Thermo Electron San Jose mailing list. As a member of this list, you receive application reports and technical reports in your area of interest, and you are notified of events of interest, such as user meetings. Second, it allows you to tell us what you like and do not like about the manual.

The Change of Location card allows us to track the whereabouts of the instrument. Fill out and return the card if you move the instrument to another site within your company or if you sell the instrument. Occasionally, we need to notify owners of our products about safety or other issues.

Chapter 1

Introduction

The LTQ™ is a member of the Finnigan™ family of MS detectors. The Finnigan LTQ MS detector is an advanced analytical instrument that includes a syringe pump, a divert/inject valve, an atmospheric pressure ionization (API) source, an MS detector, and the Xcalibur data system. In a typical analysis, a sample can be introduced in any one of the following ways:

- Using the syringe pump (direct infusion)
- Using the inject valve fitted with a loop and an LC pump (flow injection analysis)
- Using a valve and an LC system fitted with a column (LC/MS)

In analysis by LC/MS, a sample is injected onto an LC column. The sample is then separated into its various components. The components elute from the LC column and pass into the MS detector where they are analyzed. Analysis by direct infusion or flow injection provides no chromatographic separation of components in the sample before it passes into the MS detector. The data from the MS detector is then stored and processed by the Xcalibur data system.

This introduction answers the following questions:

- Why use the Finnigan LTQ MS detector?
- Which ionization technique—ESI or APCI—is better for analyzing my samples?
- How can I introduce my samples into the MS detector?
- What types of buffers should I use? What types should I avoid?
- How should I set up the MS detector for various LC flow rates?
- What is tuning and calibration of the MS detector all about?
- What types of experiments can I perform with the Finnigan LTQ MS detector?

1.1 Why Use the Finnigan LTQ MS Detector?

The attribute that sets the Finnigan LTQ MS detector apart from other LC detectors is the high level of analytical specificity that it provides. The Finnigan LTQ MS detector can provide multiple levels of analysis. Each level of analysis adds a new dimension of specificity for positive compound identification. The various levels of analysis are as follows:

- Chromatographic separation and compound detection (non MS technique utilizing chromatographic retention time)
- Mass analysis (molecular mass information)
- Two-stage mass analysis, MS/MS (structural information)
- Multi-stage mass analysis, MSⁿ (structural information)
- ZoomScan™ analysis (charge state information)

Chromatographic separation and compound detection can be obtained by all LC/detector systems. Retention time alone, however, does not positively identify a compound because many compounds can have the same retention time under the same experimental conditions. In addition, even if a compound is identified correctly by retention time, quantitation results can be in error because other compounds in the sample might co-elute with the compound of interest.

Single stage mass analysis allows for the identification of analytes of interest. Atmospheric pressure ionization typically produces mass spectra that provide molecular mass information.

Two-stage mass analysis allows for even more positive compound identification. MS/MS analysis monitors how a parent ion fragments when exposed to an additional stage of ionization. There are two types of MS/MS analysis: Full Scan MS/MS and Selective Reaction Monitoring (SRM). Full Scan MS/MS monitors the production of all product ion from a specific parent ion. SRM MS/MS analysis monitors a specific reaction path: the production of a specific product ion from a specific parent ion. Using MS/MS analysis, you can easily quantitate target analytes in complex matrices such as plant or animal tissue, plasma, urine, groundwater, or soil. Because of the specificity of MS/MS measurements and the ability to eliminate interferences by an initial mass selection stage, quantitative target compound analysis is easily accomplished using the Finnigan LTQ MS detector.

Multi-stage mass analysis provides a unique capability to obtain structural information that can be useful in structure elucidation of metabolites, natural products, and sugars. MSⁿ techniques on the Finnigan LTQ MS detector allow for stepwise fragmentation pathways, making interpretation of MSⁿ spectra relatively straightforward. The Finnigan LTQ MS detector has several

advanced features that make its MSⁿ capabilities extremely powerful for qualitative analysis. (Refer to the topic **What Types of Experiments Can I Perform with the Finnigan LTQ MS Detector?** on page 1-16.)

ZoomScan analysis provides information about the charge state of one or more mass ions of interest. ZoomScan data is collected by using slower scans at higher resolution. This allows for unambiguous determination of charge state, which in turn allows for the correct determination of molecular mass.

In addition to the aforementioned levels of analysis, there is an additional technique called Wideband Activation. The Wideband Activation option allows the Finnigan LTQ MS detector to apply collision energy to ions during MS/MS fragmentation over a fixed mass range of 20 u. This option allows the Finnigan LTQ MS detector to apply collision energy to both the parent ion, as well as to product ions created as a result of non-specific losses of water (18 u) or ammonia (17 u), for example, or to product ions formed from the loss of fragments less than 20 u. When you want enhanced structural information and you do not want to perform MS³ analysis with the Finnigan LTQ MS detector, choose the Wideband Activation option for qualitative MS/MS. Because the collision energy is applied to a broad mass range, signal sensitivity is somewhat reduced when you choose this option. Therefore, increase the value of the collision energy (Activation Amplitude) to compensate somewhat for the reduction of sensitivity.

1.2 Which MS Detector Technique—ESI or APCI—Is Better for Analyzing My Samples?

The Finnigan LTQ MS detector includes two standard atmospheric pressure ionization source probes:¹

- Electrospray ionization (ESI) probe
- Atmospheric pressure chemical ionization (APCI) probe

Typically, more polar compounds such as amines, peptides, and proteins are best analyzed by ESI, and non-polar compounds such as steroids are best analyzed by APCI.

Sample ions can carry a single charge or multiple charges. The number of charges carried by the sample ions depends on the structure of the analyte of interest, the mobile phase, and the ionization mode.

Using ESI/MS

The *ESI* mode typically produces mass spectra consisting of multiply charged ions (for proteins and peptides) depending on the structure of the analyte and the solvent. For example, the resulting mass spectrum of a higher molecular mass protein or peptide typically consists of a distribution of multiply charged analyte ions. The resulting mass spectrum can be mathematically manipulated to determine the molecular mass of the sample.

The ESI mode transfers ions in solution into the gas phase. Many samples that previously were not suitable for mass analysis (for example, heat-labile compounds or high molecular mass compounds) can be analyzed by ESI. ESI can be used to analyze any polar compound that makes a preformed ion in solution. The term *preformed ion* can include adduct ions. For example, polyethylene glycols can be analyzed from a solution containing ammonium acetate, because of adduct formation between the NH_4^+ ions in the solution and oxygen atoms in the polymer. With ESI, the range of molecular masses that can be analyzed by the Finnigan LTQ MS detector is greater than 100,000 u, due to multiple charging. ESI is especially useful for the mass analysis of polar compounds, which include: biological polymers (for example, proteins, peptides, glycoproteins, and nucleotides); pharmaceuticals and their metabolites; and industrial polymers.

You can use the ESI mode in either positive or negative ion polarity mode. The ion polarity mode is determined by the polarity of the preformed ions in solution: Acidic molecules form negative ions in high pH solution, and basic

¹Optional ionization sources [atmospheric photo ionization (APPI), atmospheric pressure matrix assisted laser desorption ionization (AP MALDI), and nanospray] are also available.

molecules form positive ions in low pH solution. A positively charged ESI needle is used to generate positive ions and a negatively charged needle is used to generate negative ions.

You can vary the flow rate from the LC into the MS detector over a range from 1 $\mu\text{L}/\text{min}$ to 1000 $\mu\text{L}/\text{min}$. Refer to Table 1-3. (In ESI, the buffer and the buffer strength both have a noticeable effect on sensitivity. Therefore, it is important to choose these variables correctly.) In the case of higher molecular mass proteins or peptides, the resulting mass spectrum consists typically of a series of peaks corresponding to a distribution of multiply charged analyte ions.

The ESI process is affected by droplet size, surface charge, liquid surface tension, solvent volatility, and ion solvation strength. Large droplets with high surface tension, low volatility, strong ion solvation, low surface charge, and high conductivity prevent good electrospray.

Mixed organic/aqueous solvent systems that include organic solvents such as methanol, acetonitrile, and isopropyl alcohol are superior to water alone for ESI. Volatile acids and bases are good, but salts above 10 mM are not recommended. Strong mineral acids and bases are extremely detrimental to the instrument.

The rules for a good electrospray are as follows:

- Keep non-volatile salts and buffers out of the solvent system. For example, avoid the use of salts containing sodium or potassium and avoid the use of phosphates. If necessary, use ammonium salts instead.
- Use organic/aqueous solvent systems and volatile acids and bases.
- If possible, optimize the pH of the solvent system for your analyte of interest. For example, if your analyte of interest contains a primary or secondary amine, your mobile phase should be slightly acidic (pH 2 to 5). The acid pH tends to keep positive ions in solution.

Using APCI/MS

Like ESI, *APCI* is a soft ionization technique. APCI provides molecular mass information for compounds of medium polarity that have some volatility. APCI is typically used to analyze small molecules with molecular masses up to about 2000 Da.

APCI is a gas phase ionization technique. Therefore, the gas phase acidities and basicities of the analyte and solvent vapor play an important role in the APCI process.

APCI is a very robust ionization technique. It is not affected by minor changes in most variables such as changes in buffer or buffer strength. The rate of solvent flowing from the LC into the MS detector in APCI mode is typically high (between 0.2 and 2 mL/min). Refer to Table 1-3, Guidelines for setting operating parameters for LC/APCI/MS.

You can use APCI in positive or negative ion polarity mode. For most molecules, the positive-ion mode produces a stronger ion current. This is especially true for molecules with one or more basic nitrogen (or other basic) atoms. Molecules which generally produce strong negative ions, with acidic sites such as carboxylic acids and acid alcohols, are an exception to this general rule.

Although, in general, fewer negative ions are produced than positive ions, negative ion polarity can be more specific. This is because the negative ion polarity mode sometimes generates less chemical noise than does the positive mode. Thus, the signal-to-noise ratio might be better in the negative ion mode than in the positive ion mode.

1.3 Should I Use Sheath, Auxiliary, and/or Sweep Gases?

Nitrogen gas can be applied to the system using any combination of the three gas sources: Auxiliary gas, Sweep gas, and/or Sheath gas. When Sheath gas is used, nitrogen is applied as an inner coaxial gas (when used in tandem with Auxiliary gas), helping to nebulize the sample solution into a fine mist as the sample solution exits the ESI or APCI nozzle. (Sheath gas is not used with the NSI source.) When Auxiliary gas is being used, nitrogen flows through the ion source nozzle, the vapor plume is affected; the spray is focused and desolvation is improved. When Sweep gas is used, the nitrogen flows out from behind the sweep cone and can result in solvent declustering and adduct reduction.

When you are analyzing complex matrices such as plasma or non-volatile salt buffers, Sweep gas is required for ruggedness. In full-scan MS or data dependent scan experiments, the signal-to-noise ratio can be improved by application of Sweep gas. In some cases, signal intensity can be increased by using Auxiliary gas, particularly for higher LC flow rates.

All analyses are analyte dependent and require separate optimization with Sheath gas, Sweep gas, and Auxiliary gas to determine which combination will yield optimum performance. It is especially important to optimize with each gas independently before you perform experiments using MSⁿ techniques and before you perform any quantitative analysis experiments because optimum results could be achieved with any combination of Sheath, Sweep, and/or Auxiliary gas. Refer to Table 1-2 and Table 1-3 for additional information on using supplemental gas flows.

1.4 How Can I Introduce My Samples into the MS Detector?

You can introduce your samples into the MS detector in a variety of ways. Refer to Table 1-1.

The syringe pump is often used to introduce calibration solution for automatic tuning and calibrating in ESI mode. You can also use this technique to introduce a solution of pure analyte at a steady rate in ESI mode, for example, for determining the structure of an unknown compound.

You can also use a Tee union to direct samples from the syringe pump into an LC flow (without a column), which then enters the MS detector. This technique is used to introduce sample at a steady rate and at higher solvent flow rates; it is used especially for tuning in ESI or APCI on an analyte of interest. You can also use this technique to introduce a solution of pure analyte at a steady rate in ESI or APCI.

You can introduce samples from a syringe into the loop of the injector valve. You can then use the divert valve to introduce the sample into an LC flow, which then enters the MS detector. This technique is used in ESI or APCI to introduce pure analytes into the MS detector in a slug. It is useful when you have a limited quantity of pure analyte.

You can also use an LC autosampler to introduce samples into an LC flow. This technique is also used in ESI or APCI to introduce a slug of pure analyte into the LC flow and then into the MS detector.

Finally, you can perform LC/MS experiments by using an LC autosampler to introduce a mixture onto an LC column. This technique is used with ESI or APCI to separate the analytes before they are introduced sequentially into the MS detector.

You can refer to subsequent chapters in this manual and to **Finnigan LTQ Getting Connected** for plumbing diagrams for methods of sample introduction.

Table 1-1. Sample introduction techniques

	Sample Introduction Technique	Analytical Technique	Figure Reference
Syringe Pump Flow (no LC Flow)	Syringe pump*	ESI automatic tuning and calibrating ESI analysis of a pure analyte solution	Finnigan LTQ Getting Started Figure 2-5
LC Flow Without Chromatographic Separation (no column)	Syringe pump into LC flow (connected by Tee union)*	ESI or APCI automatic optimization of tuning on analyte of interest ESI or APCI analysis of a pure analyte solution	Finnigan LTQ Getting Started Figure 4-1 (ESI) Figure 6-1 (APCI)
	Loop injection into LC flow	ESI or APCI analysis of a pure analyte solution	Finnigan LTQ Getting Started Figure 5-6 (ESI) Figure 8-1 (APCI)
	Autosampler injection into LC flow (one or multiple injections)	ESI or APCI analysis of a pure analyte solution	Finnigan LTQ Getting Connected Figure 11-5 (ESI) Figure 11-8 (APCI)
LC Flow With Chromatographic Separation	Autosampler injections into LC column via LC flow (one or multiple injections)	ESI or APCI analysis of mixtures	

*Provides steady state introduction of sample (direct infusion)

1.5 What Types of Buffers Should I Use? What Types Should I Avoid?

Many LC applications use nonvolatile buffers such as phosphate and borate buffers. It is best to avoid the use of nonvolatile buffers with the MS detector because they can cause the following problems:

- Blocking the capillary in the probe
- Causing salt buildup on the spray head and thus compromising the integrity of the spray

Use volatile buffers when you use the MS detector. Many volatile buffer solutions are available that can be used instead of nonvolatile ones. Volatile buffer solutions can include the following:

- Acetic acid
- Ammonium acetate
- Ammonium formate
- Ammonium hydroxide
- Triethylamine (TEA)
- Trifluoroacetic acid

1.6 How Should I Set Up the MS Detector for Various LC Flow Rates?

The ESI probe can generate ions from liquid flows¹ of 1 $\mu\text{L}/\text{min}$ to 1.0 mL/min. This flow rate range allows you to use a wide range of separation techniques: CE, CEC, capillary LC, microbore LC, and analytical LC.

The APCI probe can generate ions from liquid flows² of 200 $\mu\text{L}/\text{min}$ to 2.0 mL/min. This flow range allows you to use microbore LC, analytical LC, and semi-preparative LC.

As you change the rate of flow of solvents entering the MS detector, you need to adjust several of the MS detector parameters, as follows:

For ESI, you need to adjust the capillary temperature and adjust the gas flow rates for the Sheath, Auxiliary, and/or Sweep gas.

For APCI, you need to adjust the capillary temperature and vaporizer temperature and adjust the gas flow rates for the Sheath, Auxiliary, and/or Sweep gas.

In general, an increase in the rate of liquid flowing into the MS detector, requires a higher temperature of the ion transfer capillary (and vaporizer) and the higher gas flow rate.

Table 1-2 provides guidelines for ESI operation for ion transfer capillary temperatures and gas flow rates for various LC solvent flow rates.

Table 1-3 provides guidelines for APCI operation for the ion transfer capillary temperature, vaporizer temperature, and gas flow rate for a range of LC solvent flow rates.

¹ The ESI probe can generate ions from liquid flows of as low as 1 $\mu\text{L}/\text{min}$. However, flows below 5 $\mu\text{L}/\text{min}$ require more care, especially with the position of the fused silica sample tube within the ESI probe.

² For the APCI probe, flows below 200 $\mu\text{L}/\text{min}$ require more care to maintain a stable spray.

Table 1-2. Guidelines for setting operating parameters for LC/ESI/MS*

LC Flow Rates	Suggested Column Size	Ion Transfer Capillary Temperature	Sheath Gas	Auxiliary and/or Sweep Gas
Infusion or LC at flow rates of < 10 $\mu\text{L}/\text{min}$	Capillary	Typical setting: 150 to 200 $^{\circ}\text{C}$	Not required Typical setting: 5 to 15 units	Not required Typical setting: 0 units
LC at flow rates from 50 to 200 $\mu\text{L}/\text{min}$	1 mm ID	Typical setting: 200 to 275 $^{\circ}\text{C}$	Required Typical setting: 20 to 40 units	Not required, but might help depending on conditions Typical setting: 0 to 20 units
LC at flow rates from 100 to 500 $\mu\text{L}/\text{min}$	2 to 3 mm ID	Typical setting: 250 to 350 $^{\circ}\text{C}$	Required Typical setting: 40 to 60 units	Not required, but usually helps to reduce solvent background ions Typical setting: 0 to 20 units
LC at flow rates from 0.4 to 1 mL/min	4.6 mm ID	Typical setting: 300 to 400 $^{\circ}\text{C}$	Required Typical setting: 60 to 100 units	Required Typical setting: 10 to 40 units

* Note: Be sure to choose either Auxiliary gas and/or Sweep gas according to the hints in the topic **Should I Use Sheath, Auxiliary, and/or Sweep Gases?**

Table 1-3. Guidelines for setting operating parameters for LC/APCI/MS*

LC Flow Rate	Ion Transfer Capillary Temperature	Vaporizer Temperature	Sheath Gas	Auxiliary and/or Sweep Gas
LC at flow rates from 0.2 to 2 mL/min	Typical setting: 150 to 225 $^{\circ}\text{C}$	Typical setting: 400 to 550 $^{\circ}\text{C}$	Required Typical setting: 40 to 100 units	Not required, but usually helps to reduce solvent background ions Typical setting: 0 to 20 units

* Note: Be sure to choose either Auxiliary gas and/or Sweep gas according to the hints in the topic **Should I Use Sheath, Auxiliary, and/or Sweep Gases?**

1.7 What is Tuning and Calibration of the MS Detector All About?

To optimize the performance of data acquisition on the Finnigan LTQ MS detector, you tune and calibrate in four steps:

- In ESI mode you infuse a calibration solution into the MS detector at a steady rate of 5 $\mu\text{L}/\text{min}$ for several minutes. In Tune Plus you observe the signal at m/z 195, the mass-to-charge ratio of caffeine in the calibration solution. Then, while observing the signal at m/z 195, you adjust probe positions and gas flows to achieve the greatest signal strength while still maintaining a stable spray of ions into the MS detector.
- Once you have established a stable spray of ions into the MS detector, you tune the MS detector. In this step, you use the automatic tuning procedure in Tune Plus to ensure that the transmission of ions into the MS detector is optimum. You observe the Tune Plus window as the Xcalibur data system tunes your Finnigan LTQ MS detector automatically.
- After your tune method is optimized, you calibrate the MS detector. In this step, you want to ensure that the calibration parameters complete automatic calibration successfully. The Calibrate dialog box in Tune Plus provides a readback of the status of the calibration parameters, both during the automatic calibration and when calibration is complete.
- Lastly, if you want to maximize the detection of one or more particular ions, you can optimize the tune of the MS detector with your analyte of interest in the ionization mode that you are going to use to analyze your samples. You choose a mass-to-charge ratio of your analyte of interest. Alternatively, you can choose an ion in the calibration solution that is closest to the mass-to-charge ratio for your ion of interest. (It is sometimes possible to acquire qualitative data without optimizing the parameters, but detection sensitivity might be compromised.)

Calibration parameters are instrument parameters whose values do not vary with the type of experiment. It is recommended that you calibrate the MS detector at least once every three months and that you check the calibration about once a week.

Automatic and semi-automatic calibration (including checking the calibration) require that you introduce calibration solution into the MS detector at a *steady flow rate* while the procedure is running. You introduce the solution directly from the syringe pump into the MS detector in the ESI/MS mode.

Tune parameters are instrument parameters whose values can vary with the type of experiment. For example, if your experiment requires quantitative data on one or more particular ions, you need to tune the MS detector with your analyte if you change any one of the parameters specific to the experiment or analyte.

Automatic and semi-automatic tuning procedures (including optimizing the collision energy) require that you introduce calibration solution, or a tuning solution of your analyte of interest, into the MS detector at a steady rate in either of two ways:

- Introduce the solution directly from the syringe pump. Refer to the topic: **Setting Up the Syringe Pump for Tuning and Calibrating** in chapter 2.
- Introduce the sample from the syringe pump into the effluent of the LC by using a Tee union. Refer to the topic: **Setting Up to Introduce Sample by Syringe Pump into Solvent Flow from an LC** in chapter 4.

The first method is good for tuning if you intend to use an experiment type at a low flow rate involving the syringe pump. The second method is useful if you intend to use an experiment type at a higher flow rate involving the LC. However, the second method of introduction puts a comparatively large amount of analyte into the MS detector. Therefore, before you can perform an analytical run to analyze for the analyte, you might need to clean the API spray shield.

Caution. Do not use calibration solution at flow rates above 10 $\mu\text{L}/\text{min}$. Ultramark 1621 can contaminate your system at high concentrations.

In most cases, you can use the tune you obtain from the automatic or semi-automatic tuning procedures for your analytical experiments. However, for some applications, you might need to tune several MS detector parameters. In that case, you would tune manually. With the manual tuning process, you introduce a tuning solution at a steady flow rate.

Note. The most important parameters that affect the signal quality during ESI/MS operation are the ion transfer capillary temperature, tube lens voltage, gases, and solution flow rate. For optimum sensitivity, tune with the instrument in the same operational mode as the mode you use for the analytical experiment.

Table 1-4 summarizes methods of sample introduction for each of the calibration and tuning procedures.

Table 1-4. Summary of methods of sample introduction for calibration and tuning

Sample/ Sample Intro	Calibrating			Tuning			
	Check	Auto	Semi- auto	Auto	Semi- auto	Manual	Collision Energy
Calibration solution/ Syringe pump	✓	✓	✓	✓	✓	✓	✓
Your tune solution/ Syringe pump				✓	✓	✓	✓
Your tune solution/ Syringe pump into LC flow by using Tee union				✓	✓	✓	✓

1.8 What Types of Experiments Can I Perform with the Finnigan LTQ MS Detector?

This topic describes several types of experiments that you can perform with the Finnigan LTQ MS detector. The experiments can be grouped into the following categories:

- General MS or MSⁿ
- Data-Dependent™
- Ion Mapping™
- Ion Tree

You can specify which type of experiment you want to perform in the Instrument Setup window, and then save it in an Instrument Method (.meth) file.

Note. Procedures for these experiments are beyond the scope of this **Finnigan LTQ Getting Started** manual. If you need more information, refer to online Help.

General MS or MSⁿ Experiments

General MS or MSⁿ

A General MS or MSⁿ experiment is best used for the quantitative analysis of known compounds. However, you can also use a General experiment to collect qualitative data for structural analysis. The Xcalibur data system includes an Instrument Method template in Instrument Setup so you can get started with a General MS or MSⁿ experiment. For an example of a General MS or MSⁿ experiment template, see Figure 1-1

In a General *MS* quantitation experiment, you need to specify the mass range of your analyte(s) of interest. In a General *MS/MS* quantitation experiment, you need to specify a parent (precursor ion) that fragments into distinctive product ions. In a General *MSⁿ* quantitation experiment, you need to specify the mass-to-charge ratios of *all* the parent ions of interest. The Finnigan LTQ MS detector can then collect data on the ions in the range or on the product ions of the parent ion(s) that you specify.

If you use a General experiment to collect data for qualitative (structural) analysis, you specify the scan mode (MS through MSⁿ) for which you want data in the Scan Event Settings group box. If you specify MS/MS or MSⁿ, you then choose the parent ion(s) for which you want data in the MSⁿ Settings table. The Finnigan LTQ MS detector can then collect distinct qualitative information for structural analysis or for spectral reference.

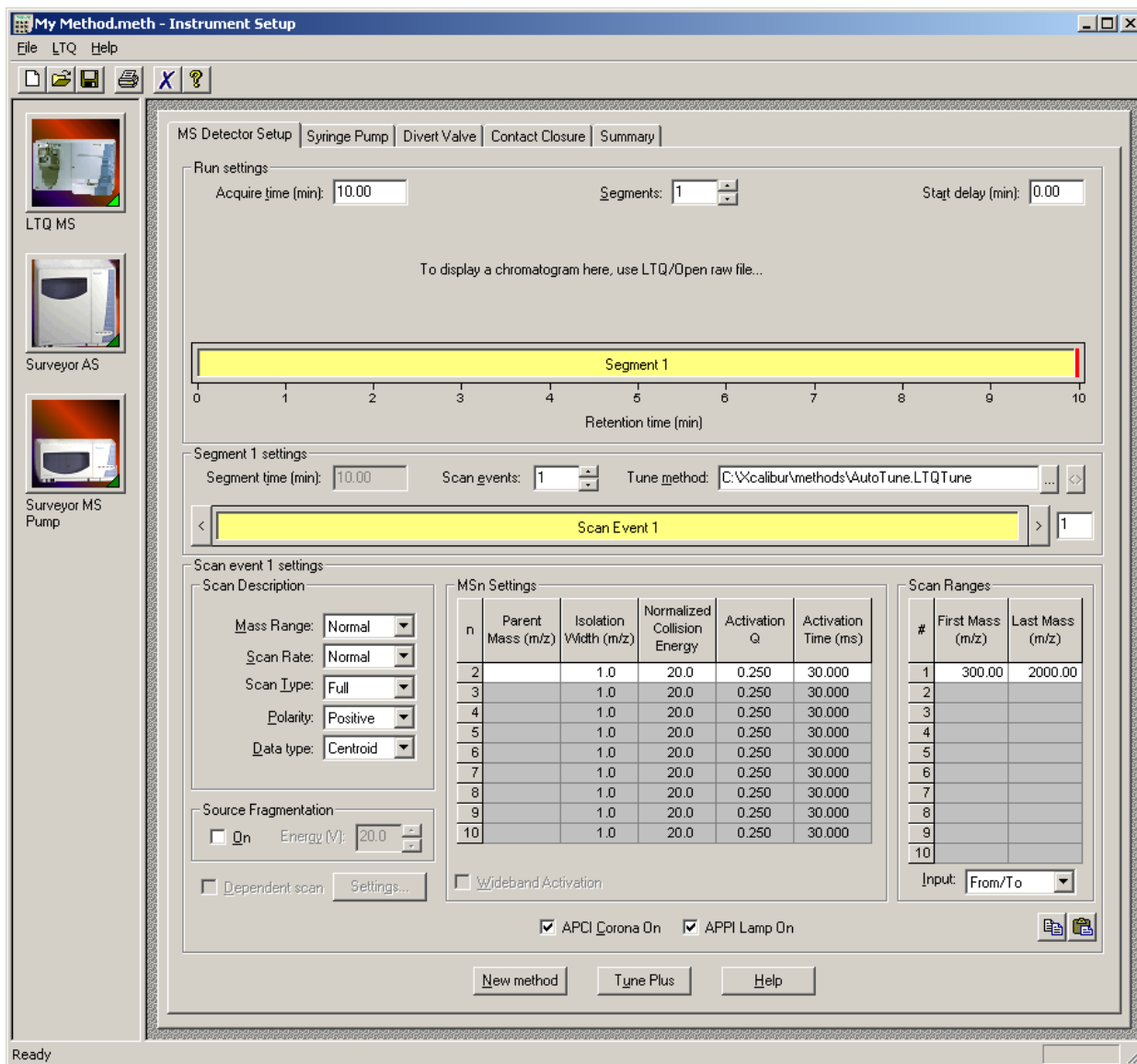

Figure 1-1. MS Detector Setup page in Instrument Setup, showing a template for a General MS experiment

The Finnigan LTQ MS detector can generate reproducible, analyte-specific spectra, even from laboratory to laboratory. Consequently, reference spectra that are generated with the Finnigan LTQ MS detector can be used to confirm structures of compounds generated with other Finnigan LTQ systems.

Data-Dependent Experiments

Data dependent MS/MS

Data dependent triple play

A Data-Dependent experiment is best used for the qualitative analysis of unknown compounds for structure elucidation or confirmation. The Finnigan LTQ MS detector uses the information in a Data-Dependent experiment to make decisions about the next step of the experiment automatically—without input from a user. Instrument Setup contains the Instrument Method templates that you need to get started with Data-Dependent experiments. For an example of a Data-Dependent Triple Play experiment template, see Figure 1-2.

A Data-Dependent experiment produces a great deal of data from a single sample analysis. You can run a Data-Dependent experiment even if you know very little about your sample, and even if you are unfamiliar with the variables of mass spectroscopy. In a Data-Dependent experiment, you can specify parent ions for fragmentation or you can let the Finnigan LTQ MS detector automatically select the ions for fragmentation. The Finnigan LTQ MS detector can collect the structural information for every parent ion in the sample automatically, even if the sample is a mixture of compounds.

A Data-Dependent experiment requires minimal input from a user about how the experiment should best proceed. The user specifies that one or more scan events of an experiment segment are to be run as Data-Dependent. Then, the Finnigan LTQ MS detector collects MS/MS or MSⁿ data and makes decisions about what the next step in the experiment should be to collect even more data. For example, in a Data-Dependent Triple Play experiment for a mixture of compounds, the Finnigan LTQ MS detector can decide which parent ion to isolate, the charge state of the parent ion, and the molecular mass of the compound.

Ion Mapping experiments can be Data-Dependent. (The Total Ion Map, Neutral Loss Ion Map, and Parent Ion Map experiments are *not* Data-Dependent.) The Data-Dependent Zoom Map experiment collects ZoomScan data on every scan interval in a specified mass range.

Ion Tree experiments are types of Data-Dependent experiments. These experiments provide methods for automatically interpreting MSⁿ data and arranging the data in formats that are easy to manipulate.

You can approach the setup of Data-Dependent experiments in either of two ways:

- If you have some idea of the parent ion, or if you expect a certain kind of parent, you can set up a list of possible parent ions. Then, when one of the parent ions you specified is detected, you can acquire product spectra and analyze the information. Conversely, you can also set up a list of ions that you do not want to be selected for fragmentation.

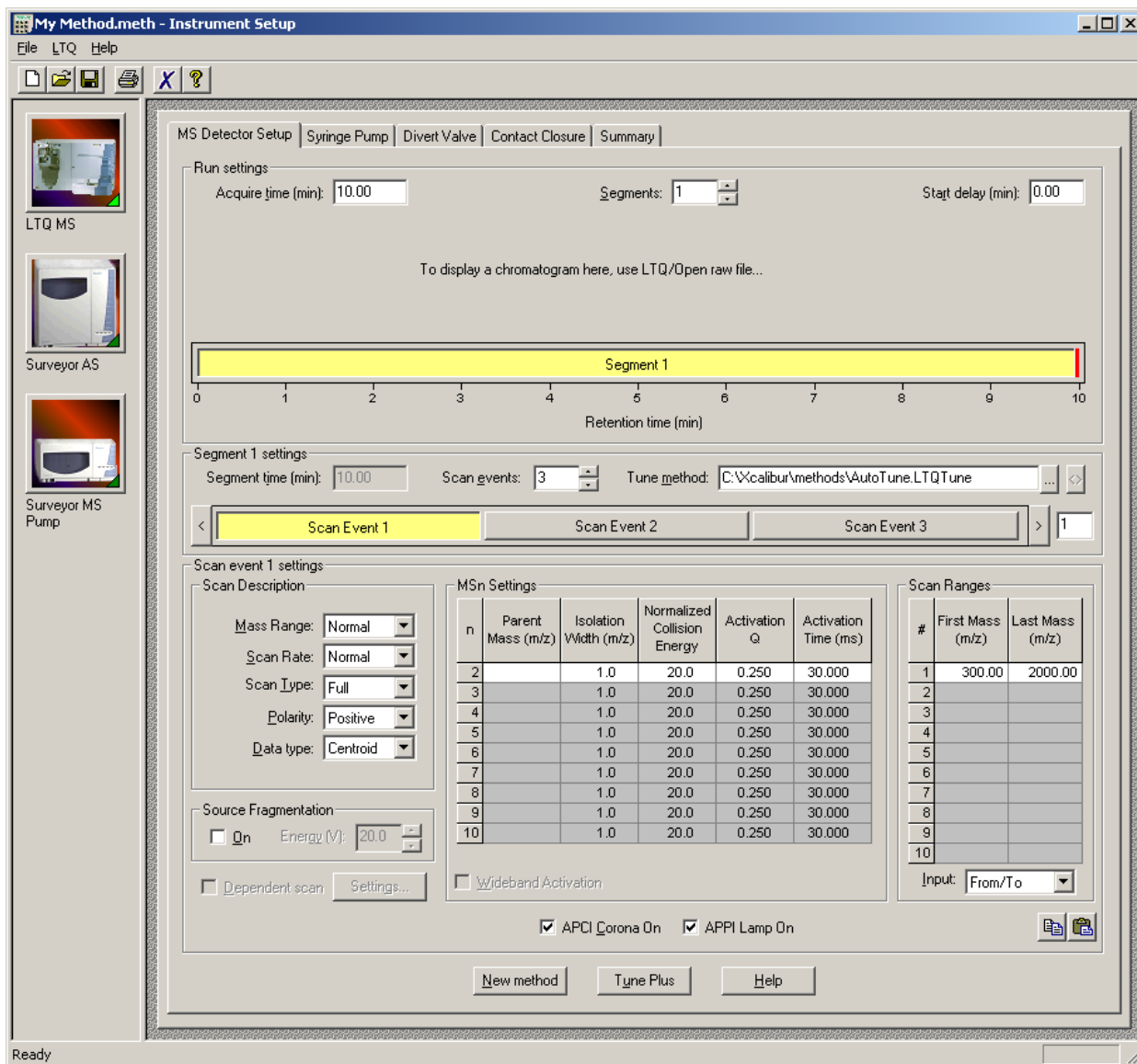

Figure 1-2. MS Detector Setup page in Instrument Setup, showing a template for a Data-Dependent Triple Play experiment. (To select a scan event that makes active the Dependent Scan check box, you click on either the Scan Event 2 or Scan Event 3 button.)

- If you have little information about your compound, you can set up the parameters of a Data-Dependent experiment so that if the intensity of the ion signal is above a specified threshold, the Finnigan LTQ MS detector generates product spectra. Parameters that you might specify, for example, include threshold values for the intensity of the MS or MSⁿ ion signal. Whatever threshold values you choose should accomplish the isolation of your parent ions of interest.

You can find useful structural information about your compound automatically with the simplest Data-Dependent experiment, Data-Dependent MS/MS. You specify the MS scan range, and you do not even need to specify a parent ion. The Finnigan LTQ MS detector can then collect full scan MS data, pick the most intense parent ion in the spectrum, and fragment the ion to generate product ions.

A Data-Dependent Triple-Play experiment is the same as Data-Dependent MS/MS, but includes the identification of the charge state of the parent with the Finnigan LTQ ZoomScan feature. A Data-Dependent Triple-Play experiment collects full scan MS data, and then uses ZoomScan to determine the charge state of the parent ion and calculate the molecular mass. The parent ion is then fragmented into product ions (MS/MS). For example, if the Finnigan LTQ MS detector determines a charge state equal to 2, and if the mass-to-charge ratio of the parent ion is m/z 500, then the mass-to-charge ratios of the product ions can be up to m/z 1000 (or 2×500).

You can use a Data-Dependent experiment (from templates in Instrument Setup) to do the following:

- Identify low-level impurities in high-purity compounds (Data-Dependent MS/MS)
- Identify metabolites in a complex mixture (Chromatographic Separation with Data-Dependent MS/MS)
- Build a custom library of composite MSⁿ spectra (Ion Tree)

You can use a Data-Dependent MSⁿ experiment to identify process impurities. In the quality assurance process for aspirin, for example, the Finnigan LTQ MS detector can identify impurities of less than 0.1%.

A Data-Dependent MS/MS experiment of a complex mixture of drug metabolites can provide highly specific structural information. Characteristic masses along the metabolic pathways of a drug, for example, can produce MS/MS spectra that are specific to the structure of the drug. These spectra are essential in metabolite identification.

A Data-Dependent experiment can produce a composite spectrum of, for example, MS₂, MS₃, and MS₄ data. The Finnigan LTQ MS detector can store the MSⁿ fingerprint data in a custom MSⁿ library spectrum. The data is valuable for use in process control, quality assurance, or research.

Ion Mapping Experiments

Ion mapping...

An Ion Mapping experiment is best used to get full structural characterization of unknown molecules in complex mixtures. In an Ion Mapping experiment, you can get product ion scans on every parent ion over a specified mass range. An Ion Mapping experiment can help to identify automatically which parent ions were fragmented to yield a specified product ion. The experiment “maps” one or more parent ions by using the information from product ion scans.

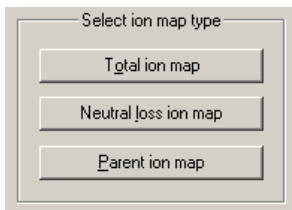

The Finnigan LTQ MS detector includes the following Ion Mapping templates in Instrument Setup so you can get started with an Ion Mapping experiment:

- Total (or full scan) Ion Map
- Neutral Loss Ion Map
- Parent Ion Map

These Ion Mapping experiments, in general, require that sample solution enter the MS Detector at a composition that is constant throughout. Therefore, you use infusion to introduce your sample for these Ion Mapping experiments. See Figure 1-3 for an example of an Ion Mapping experiment template.

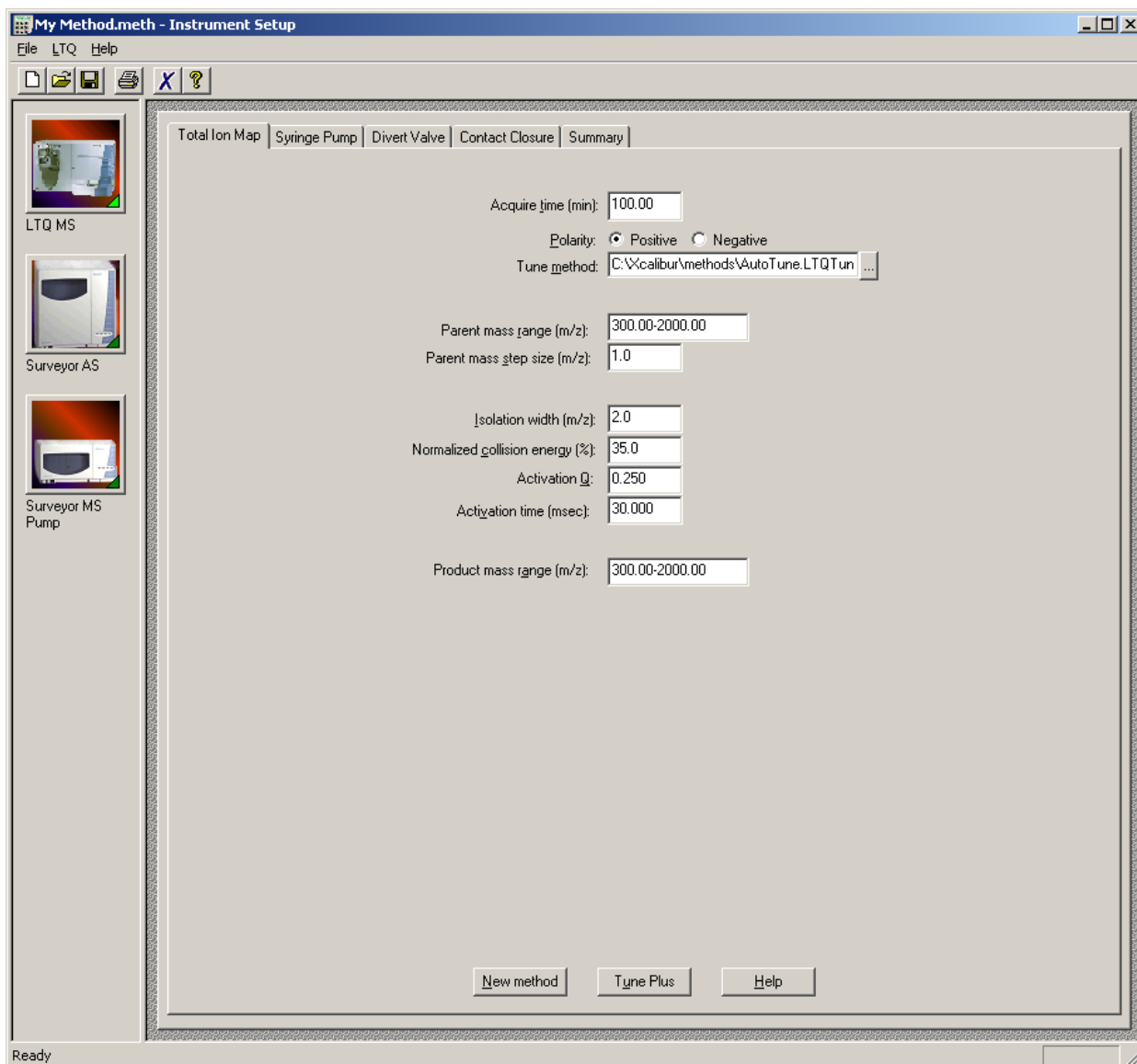

Figure 1-3. Total Ion Map page in Instrument Setup, showing a template that contains parameters for an Ion Mapping experiment

In a Total (or full scan) Ion Mapping experiment, you get product ion scans for each parent ion, so you can determine which parent ions lost a particular fragment to yield a particular product ion. Furthermore, you can determine which parent ions are related to specific product ions. For example, you can map the spectral peaks in a mass range from m/z 400 to m/z 2000 and specify to scan for MS/MS product ions in incremental steps of every mass-to-charge ratio, every fifth mass-to-charge ratio, or every tenth mass-to-charge ratio.

A Neutral Loss Ion Mapping Experiment collects scans for masses that have lost neutral fragments. As with Full Scan Ion Mapping, you can get product ion scans on every parent ion. However, a Neutral Loss Ion Map identifies which parent ions lost a neutral fragment of a particular mass. For example, you can specify a neutral loss of 80 u (as in the case of a phosphorylated peptide in a tryptic digest). A Neutral Loss Ion Mapping experiment can step through each product mass in the mixture. The experiment searches for evidence of the loss of a neutral moiety of mass 80 u.

A Parent Ion Mapping experiment identifies all the ions that produce a particular molecular ion that you specify. For example, if you specify a product ion mass of m/z 50, a Parent Ion Map includes all the parent ions that yielded the specified product ion, m/z 50.

A Data-Dependent Zoom Map is an Ion Mapping experiment that collects ZoomScan data on every scan interval in a mass range that you specify, as well as Data-Dependent MS/MS product spectra on every mass above an intensity threshold.

The results of any of the Ion Mapping experiments can be viewed in the Xcalibur Qual Browser window.

Ion Tree Experiments

Data dependent ion tree

In an Ion Tree experiment, the Finnigan LTQ MS detector can collect MSⁿ data automatically. You can specify a particular parent ion for fragmentation, or you can let the Finnigan LTQ MS detector find the parent ions automatically and fragment them to any level between MS₂ and MS₁₀. The Finnigan LTQ MS detector automates the collection of data by deciding what actions need to occur next for the experiment to progress. See Figure 1-4 for an example of an Ion Tree experiment template.

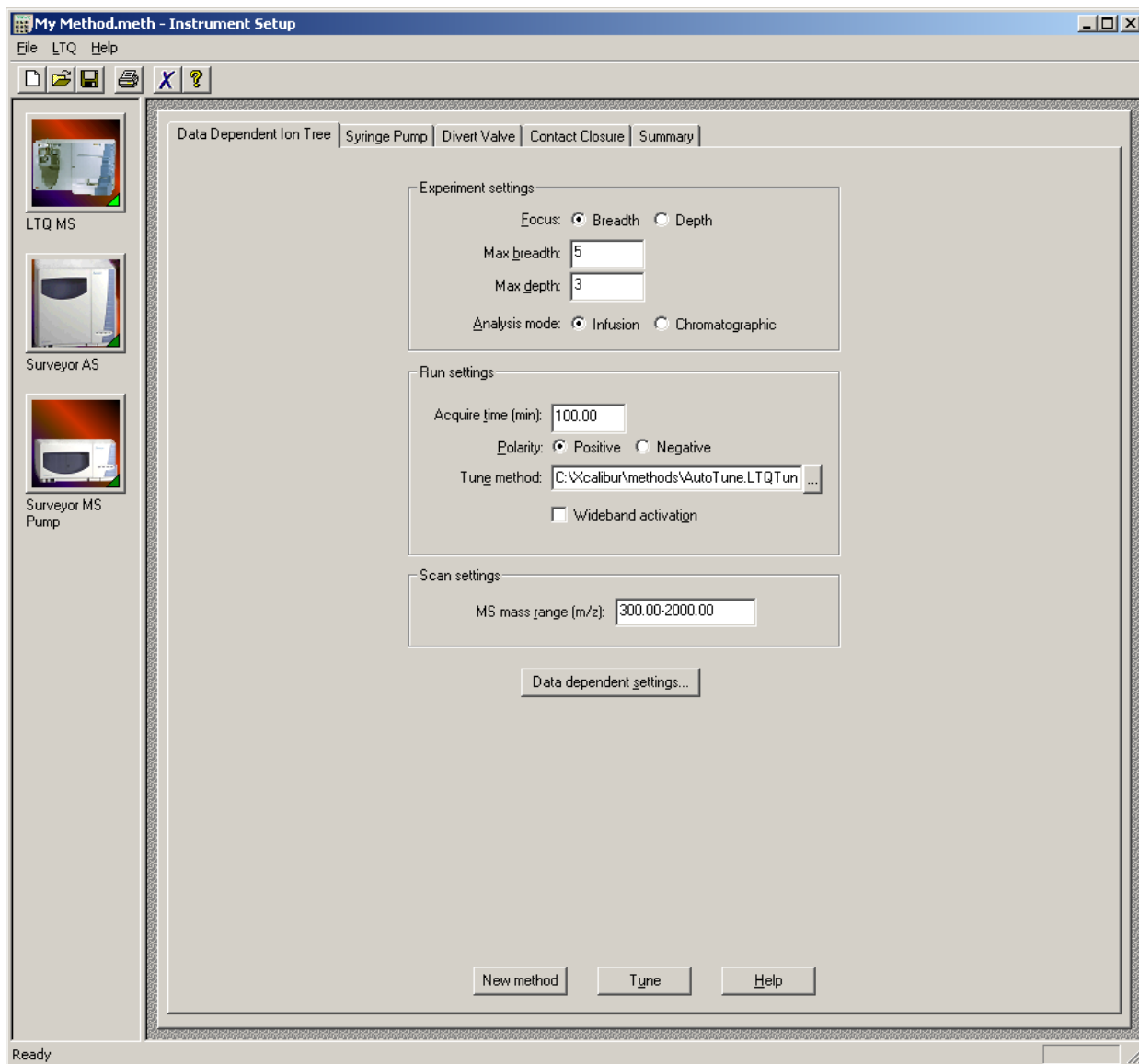

Figure 1-4. Data-Dependent Ion Tree page in Instrument Setup, showing a template for an Ion Tree experiment

In an Ion Tree experiment, you can specify either of two options that prioritize how the Finnigan LTQ MS detector gathers information:

Depth Focus and *Breadth Focus*.

- Depth Focus characterizes an ion by performing a series of MSⁿ-level fragmentations (for example, MS/MS, MS³, MS⁴, etc.) before characterizing the next most intense ion in the MSⁿ series.
- Breadth Focus characterizes all ions to the same MSⁿ level before advancing to the next MSⁿ level.

For example, if you specify a *Maximum Depth* of 3 and a *Maximum Breadth* of 2 in an Ion Tree experiment, the following occurs.

First, with either Depth or Breadth Focus, the Finnigan LTQ MS detector scans for parent ions (MS) over the specified mass range. The most intense ion of the MS spectrum is selected for fragmentation (MS/MS).

- Second, if you chose the Depth Focus, after the most intense ion of the MS spectrum is fragmented—producing an MS/MS spectrum—the Finnigan LTQ MS detector selects and fragments the most intense ion of the MS/MS spectrum. This results in an MS3 spectrum, the level specified as the maximum depth for this example. The Finnigan LTQ MS detector then backs up one level and fragments the second most intense ion of the MS/MS spectrum, creating more product ions on the level of MS3 from this parent ion. This process is then repeated for the second most intense ion in the MS spectrum.
- If you chose the Breadth Focus, after the most intense ion of the MS spectrum is fragmented—producing an MS/MS spectrum—the Finnigan LTQ MS detector selects and fragments the second-most intense ion of the *same* MS spectrum. The fragmentation of parent ions continues to the *Max Breadth* level that you specified (2, for this example). After the two most intense peaks on the MS level are fragmented, the Finnigan LTQ MS detector scans the first MS/MS spectrum to select and fragment the two most intense ions. This results in product ions on the level of MS3, the level specified as the maximum depth for this example. This process is then repeated for the second most intense ion in the MS spectrum.

The results of a Data-Dependent Ion Tree experiment can be viewed in the Xcalibur Qual Browser window. The results are displayed as a structure tree that originates from a particular parent ion.

Chapter 2

Setting Up the Ion Source for Tuning and Calibrating the MS Detector

This chapter provides information on setting up the hardware for tuning and calibrating your Finnigan LTQ MS detector. You tune and calibrate the MS detector in the ESI mode before you acquire data in either the ESI or APCI mode.

This chapter contains the following topics:

- Placing the LC/MS System in Standby
- Removing the APCI Probe
- Removing the Ion Max Ion Source Housing (optional)
- Installing the Ion Sweep Cone (optional)
- Installing the Ion Max Ion Source Housing
- Installing the ESI Probe

2.1 Placing the LC/MS System in Standby

The LC/MS system needs to be placed in Standby condition before you can remove the ion source. Use the following procedure to place the LC/MS system in Standby:

1. If necessary, stop the flow of solvent to the API source as follows:
 - a. If the Xcalibur data system is not already open, choose **Start > Programs > Xcalibur > Xcalibur** from the Windows[®] taskbar to open the Xcalibur window.
 - b. In the Xcalibur Home Page window – Roadmap view, choose **GoTo > Instrument Setup** to open the Instrument Setup window.
 - c. Click on the Surveyor[®] MS Pump button on the view bar in the Instrument Setup window to display the Surveyor MS Pump view.
 - d. Choose **Surveyor MS Pump > Direct Control** to open the Surveyor MS Pump Direct Control dialog box.
 - e. In the Direct Control dialog box, click on the Pump Off button to stop the MS pump.
2. If Tune Plus is not already open, choose **Start > Programs > Xcalibur > LTQTune** from the taskbar to open Tune Plus.

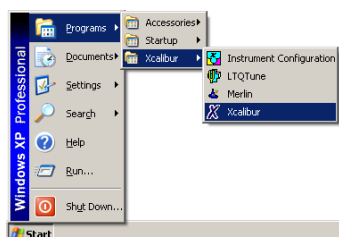

On



Off



Standby

- You can determine the state of the MS detector by observing the state of the On/Standby button on the Control / Scan Mode toolbar. (The three different states of the On/Standby button are shown at the left.)
3. If the MS detector is On, click on the On/Standby button to place the MS detector in the Standby mode. When the MS detector is in Standby, the Finnigan LTQ MS detector turns off the ion source sheath gas, auxiliary gas, and high voltage.

The LC/MS system is now in Standby and it is safe to remove the ion source.

If the ESI probe is already installed in the Ion Max[™] ion source housing, leave the LC/MS system in Standby and go to the next chapter: **Tuning and Calibrating the MS detector in ESI/MS/MS Mode.**

If the ESI probe is not already installed in the Ion Max ion source housing, go to the next topic: **Removing the APCI Probe.**

2.2 Removing the APCI Probe

This topic describes how to remove the APCI probe from the Ion Max ion source housing.

Note. The following procedures assume that you are familiar with your instrument and software. If you need additional guidance, refer to Finnigan LTQ online Help, **Finnigan LTQ Getting Connected**, **Finnigan Ion Max API Source Hardware Manual**, or the **Finnigan LTQ Hardware Manual**.



CAUTION. AVOID BURNS. At operating temperatures, the APCI vaporizer can severely burn you! The APCI vaporizer typically operates between 400 and 600 °C. **Always allow the heated vaporizer to cool to room temperature (for approximately 20 min) before you touch or remove this component.**

Remove the APCI probe as follows:

1. Unplug the vaporizer heater cable from the vaporizer heater cable socket on the APCI probe. See Figure 2-1.
2. Disconnect the sample transfer line from the APCI probe. (See Figure 2-1.)
3. Remove the auxiliary gas line (green colored fitting) from the APCI probe. (Figure 2-1)
4. Remove the sheath gas line (blue colored fitting) from the APCI probe.

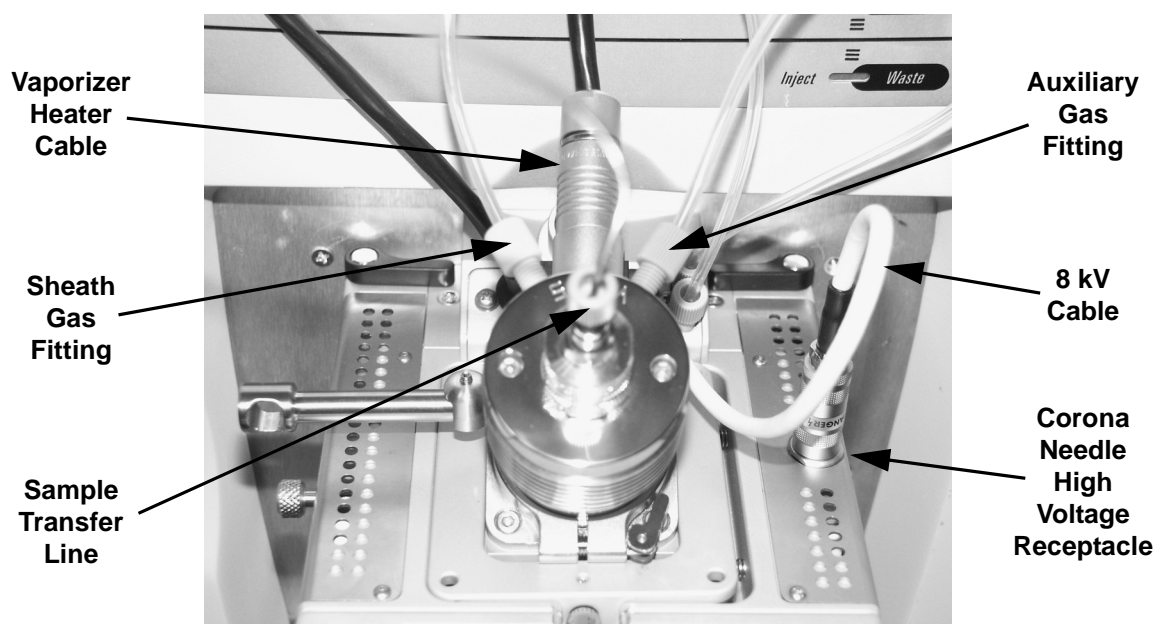

Figure 2-1. Ion Max ion source housing with APCI probe installed



CAUTION. AVOID BURNS. At operating temperatures, the APCI vaporizer can severely burn you! The APCI vaporizer typically operates between 400 and 600 °C. **Always allow the heated vaporizer to cool to room temperature (for approximately 20 min) before you touch or remove this component.**

5. Remove the APCI probe as follows:
 - a. Connect the vaporizer heater cable to the ESI interlock socket on the ion source housing. See Figure 2-2.
 - b. Release the probe locking lever to loosen the probe collar. You might need to unscrew the lever a few turns to permit probe movement.
 - c. Carefully pull the probe straight back in the port in the housing until it meets with the slot in the API interlock block. The guide pin on the probe manifold will prevent you from rotating the probe until the pin is aligned with the slot in the API interlock block. Once the probe is all the way back and aligned with the slot, turn the probe 45 degrees counter-clockwise to free the probe from the alignment notch.
 - d. Pull the probe straight out to remove it from the ion source housing.
 - e. Store the APCI probe in its original shipping container.

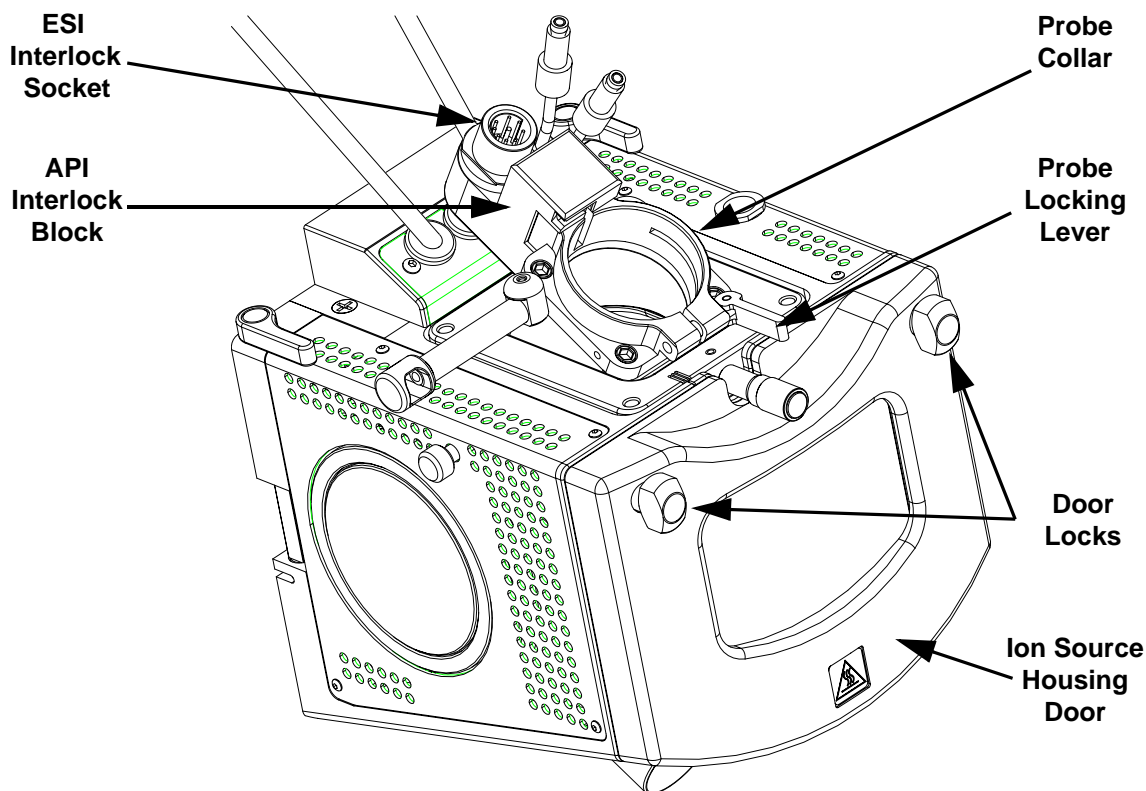

Figure 2-2. Ion Max ion source housing, detail of components

6. Remove the 8 kV cable from the corona needle high voltage receptacle as follows:
 - a. Unlock the cable by rotating the locking ring counter-clockwise.
 - b. Unplug the 8 kV cable from the corona needle high voltage receptacle.



CAUTION. AVOID INJURY. The corona discharge needle is very sharp and can puncture your skin. Handle it with care.

7. Remove the corona needle as follows:
 - a. Unlock the ion source housing door by turning the locks 90 degrees so that the knobs are horizontal.
 - b. Open the ion source housing door.
 - c. Using pliers, grasp the needle by the corona needle contact and pull the needle straight out of the socket. See Figure 2-3.
 - d. Close and lock the ion source housing door.

8. Store the corona needle in its original shipping container.

The APCI probe and the corona needle are now properly removed from the Ion Max ion source housing.

If you want to install the optional ion sweep cone, go to the next topic:

Removing the Ion Max Ion Source Housing.

If you do not want to install the ion sweep cone, go to the topic: **Installing the ESI Probe.**

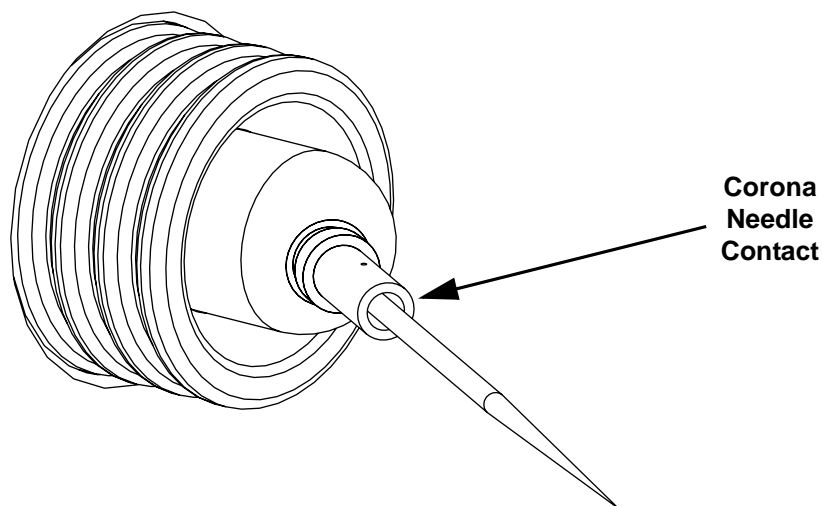

Figure 2-3. Corona needle, view from rear

2.3 Removing the Ion Max Ion Source Housing

The Ion Max ion source housing is removed to access the ion sweep cone.

Note. If an ion source probe is still installed in the ion source housing, the external liquid lines should first be disconnected before removing the ion source housing.

Remove the ion source housing as follows:

1. Remove the drain tube from the ion source housing drain. See Figure 2-4.
2. Rotate the ion source housing locking levers 90 degrees to release the ion source housing from the ion source mount assembly.
3. Remove the ion source housing by pulling the housing straight off of the ion source mount assembly
4. Place the ion source housing in a safe location for temporary storage.

The Ion Max ion source housing is now properly removed.

Go to the next topic: **Installing the Ion Sweep Cone.**

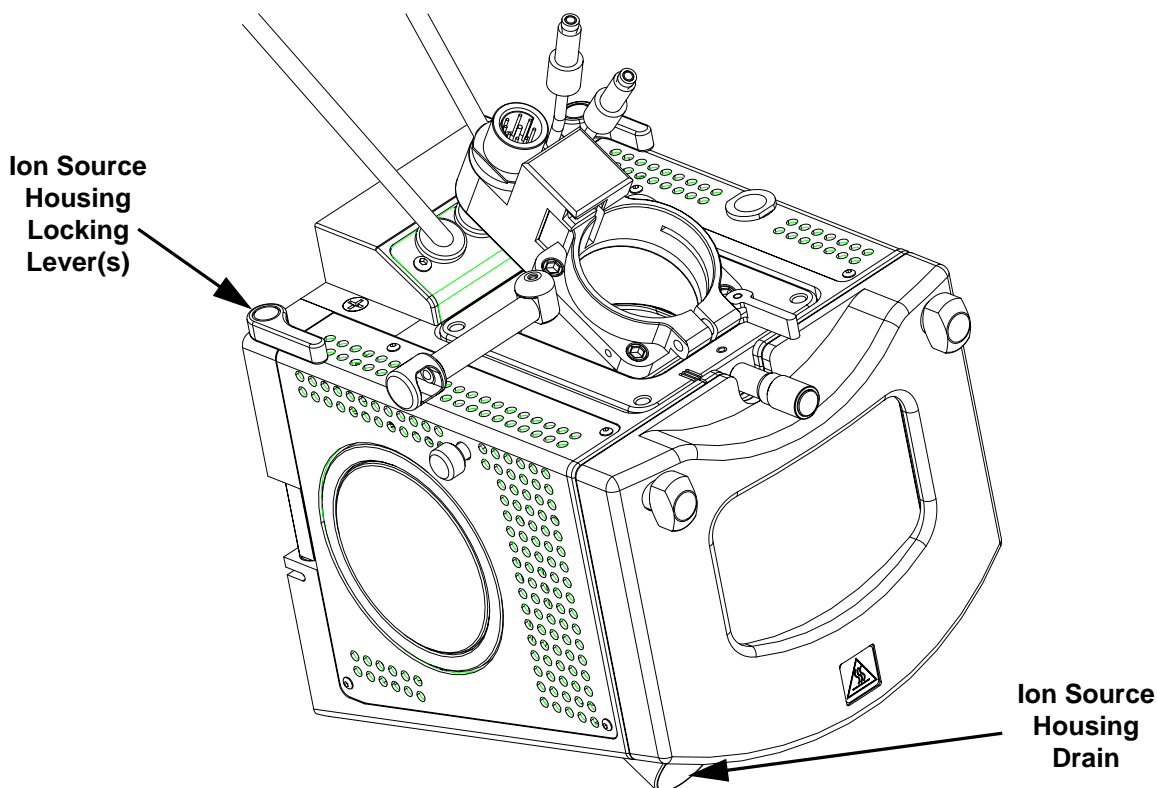

Figure 2-4. Ion Max ion source housing, detail of components

2.4 Installing the Ion Sweep Cone

The *ion sweep cone* is a metallic cone that is installed over the ion transfer tube. The ion sweep cone channels the sweep gas towards the entrance of the capillary. This helps to keep the entrance of the ion transfer tube free of contaminants. The net result is a significant increase in the number of samples that can be analyzed without a loss of signal intensity. In addition, keeping the ion transfer tube entrance cleaner reduces the need for frequent MS detector maintenance.

Install the ion sweep cone as follows:

1. Remove the ion sweep cone from its storage container. Inspect and clean it if necessary.
2. Note the location of the sweep gas supply port in the API cone seal. The gas inlet on the ion sweep cone is placed in this port. See Figure 2-5 and Figure 2-6.

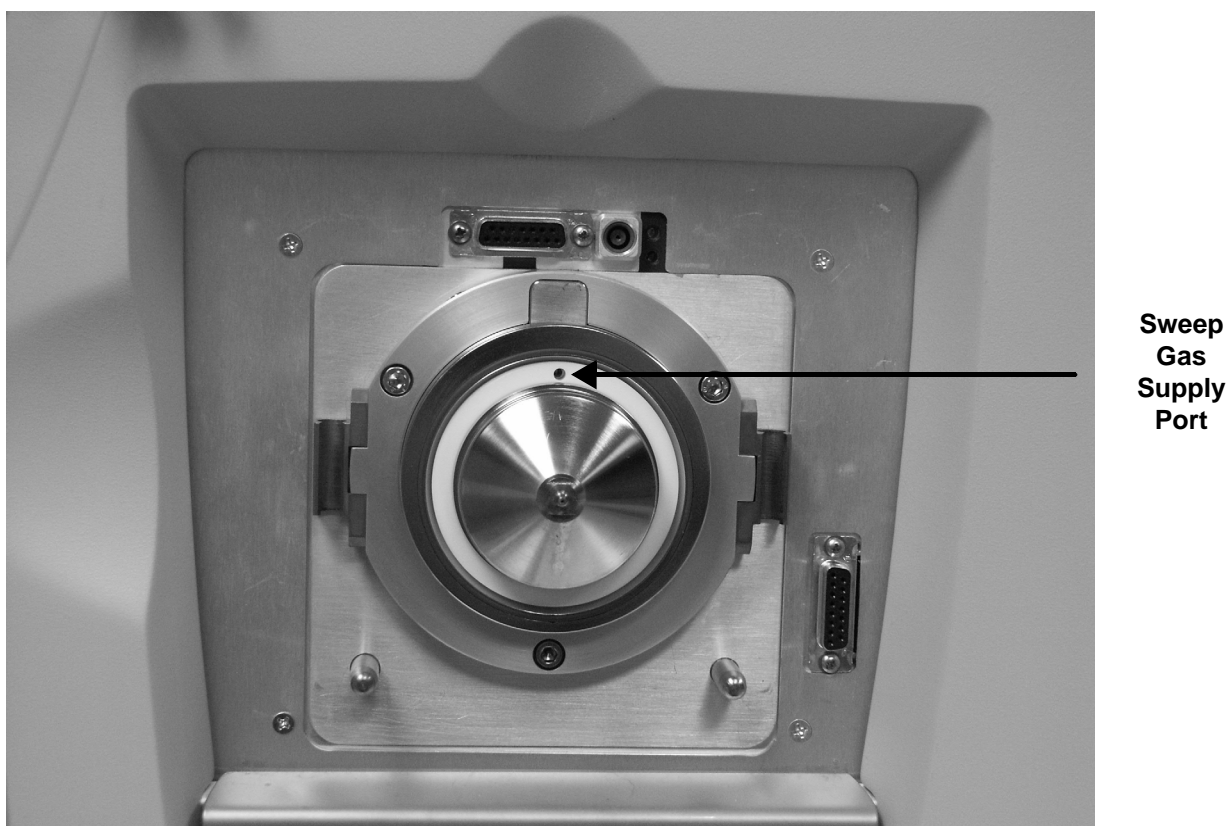

Figure 2-5. Sweep gas supply port in the API cone seal

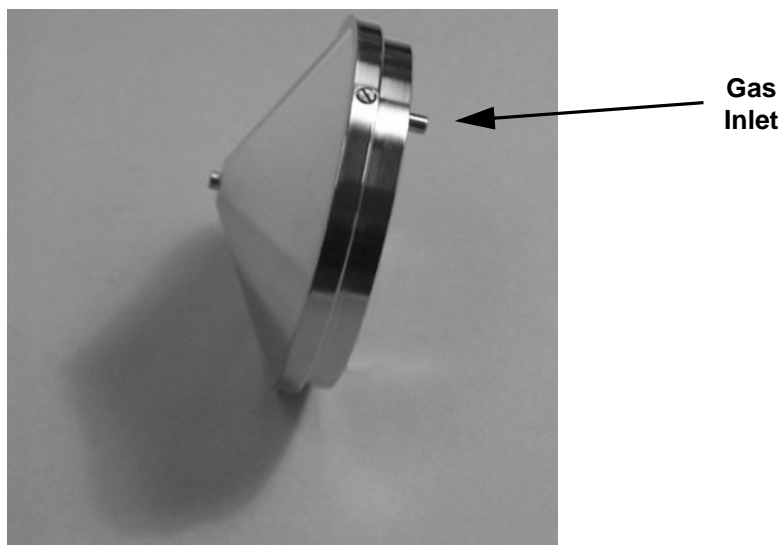

Figure 2-6. Ion sweep cone, showing the gas inlet



CAUTION. AVOID BURNS. At operating temperatures, the ion transfer tube can severely burn you! The ion transfer tube typically operates between 200 and 400 °C. **Always allow the ion transfer capillary to cool to room temperature (for approximately 20 min) before you install the ion sweep cone.** Always be careful not to touch the entrance end of the ion transfer tube when it is exposed.

3. After the ion transfer tube has cooled to room temperature, carefully align the gas inlet on the ion sweep cone with the sweep gas supply port in the API cone seal. Firmly press the ion sweep cone into position.
4. If necessary to achieve a proper ion sweep cone installation, you might adjust the set screws around the perimeter of the ion sweep cone.

The ion sweep cone is now properly installed on the MS detector.

Go to the next topic: **Installing the Ion Max Ion Source Housing.**

2.5 Installing the Ion Max Ion Source Housing

Reinstall the Ion Max ion source housing as follows:

1. Carefully align the two guide pin holes on the rear of the ion source housing with the ion source housing guide pins on the MS detector, and carefully press the ion source housing onto the ion source mount. See Figure 2-7 and Figure 2-8.

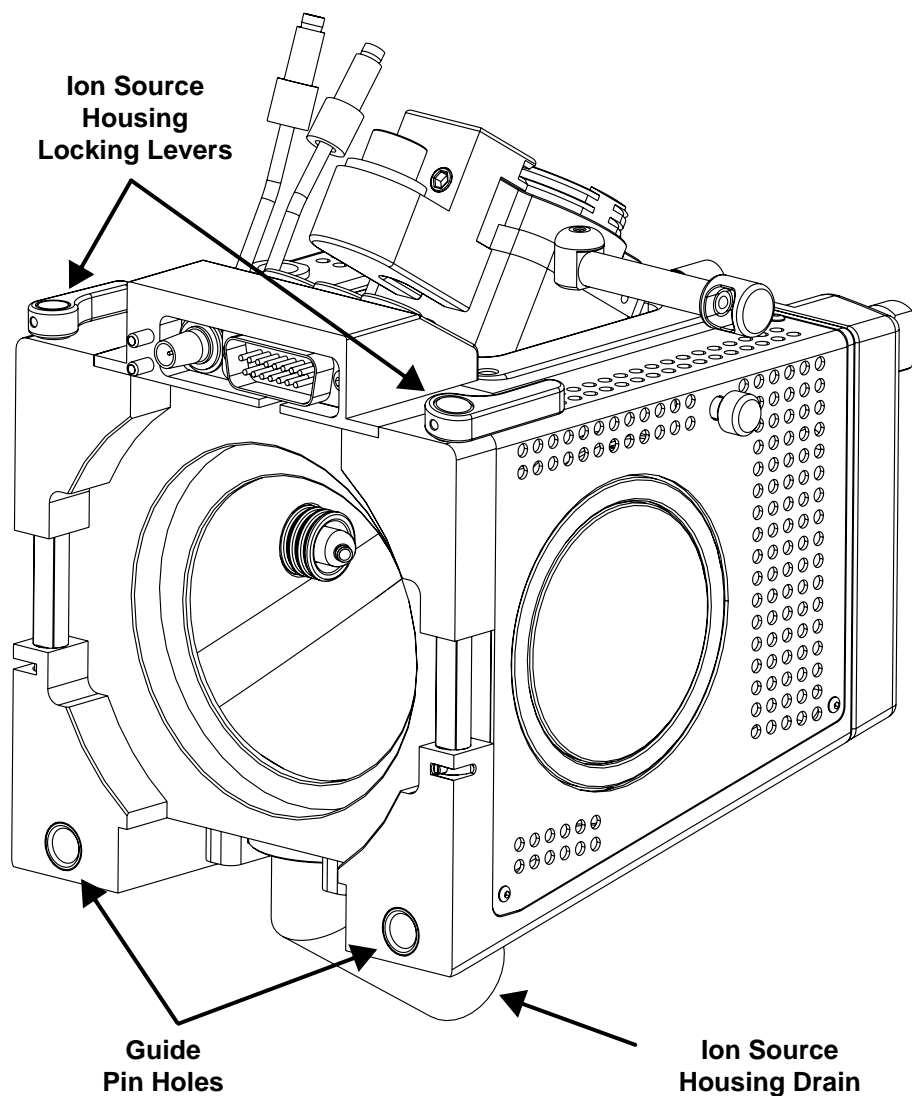

Figure 2-7. Rear view of the Ion Max ion source housing

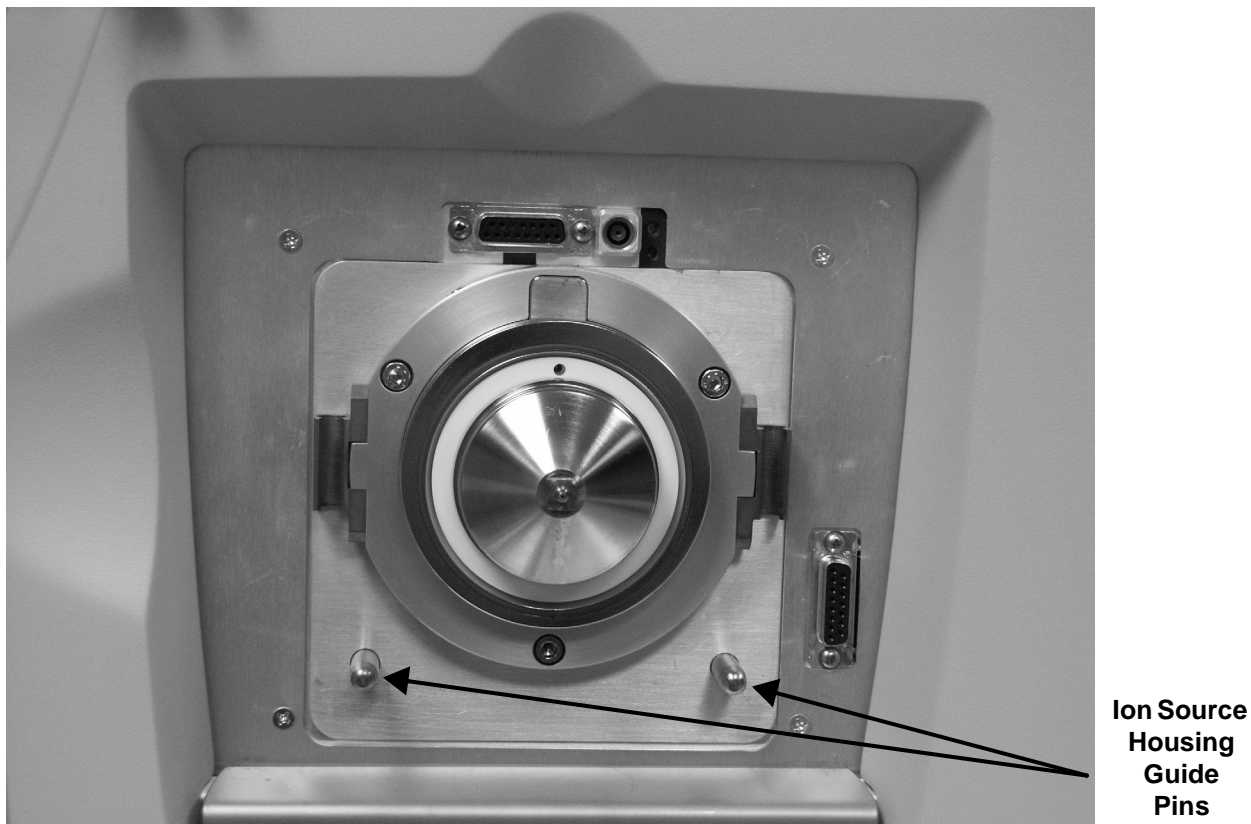

Figure 2-8. Ion source mount showing ion source housing guide pins

2. Rotate the ion source housing locking levers 90 degrees to lock the ion source housing onto the ion source mount assembly.

Caution. Prevent solvent waste from backing up into the ion source and MS detector. Always ensure that liquid in the drain tube is able to drain to a waste container.

3. Reinstall the ion source drain tube as follows:

Caution. Do **not** vent the API source drain tube (or any vent tubing connected to the waste container) to the same fume exhaust system to which you have connected the forepumps. The analyzer optics can become contaminated if the API source drain tube and the (blue) forepump exhaust tubing are connected to the same fume exhaust system.

Your laboratory must be equipped with at least two fume exhaust systems. Route the (blue) forepump exhaust tubing to a dedicated fume exhaust system. Route the drain tube from the API source to a waste container. Vent the waste container to a dedicated fume exhaust system.

- a. Connect the 1-in. ID Tygon® tubing to the ion source housing drain.
- b. Attach the free end of the hose to a dedicated drain system. Ideally, the drain system should be vented to a fume exhaust system.

The Ion Max ion source housing is now properly installed on the MS detector.

Go to the next topic: **Installing the ESI Probe.**

2.6 Installing the ESI Probe

Install the ESI probe as follows:

1. Remove the ESI probe from its storage container. Inspect and clean it if necessary.

Note. If your ESI probe does not already have a sample tube (fused-silica capillary or metal needle) and safety sleeve attached, you need to follow the procedure for installing a sample tube and PEEK safety sleeve that is outlined in the topic **Installing a New Fused-Silica Sample Tube and PEEK Safety Sleeve** in the **Finnigan Ion Max API Source Hardware Manual**.

2. Ensure that the probe locking lever on the ion source housing is unlocked (opened to its widest position). See Figure 2-9.
3. Insert the ESI probe into the port in the ion source housing, align the guide pin on the probe body at a minus 45 degree angle from the API interlock block. See Figure 2-10

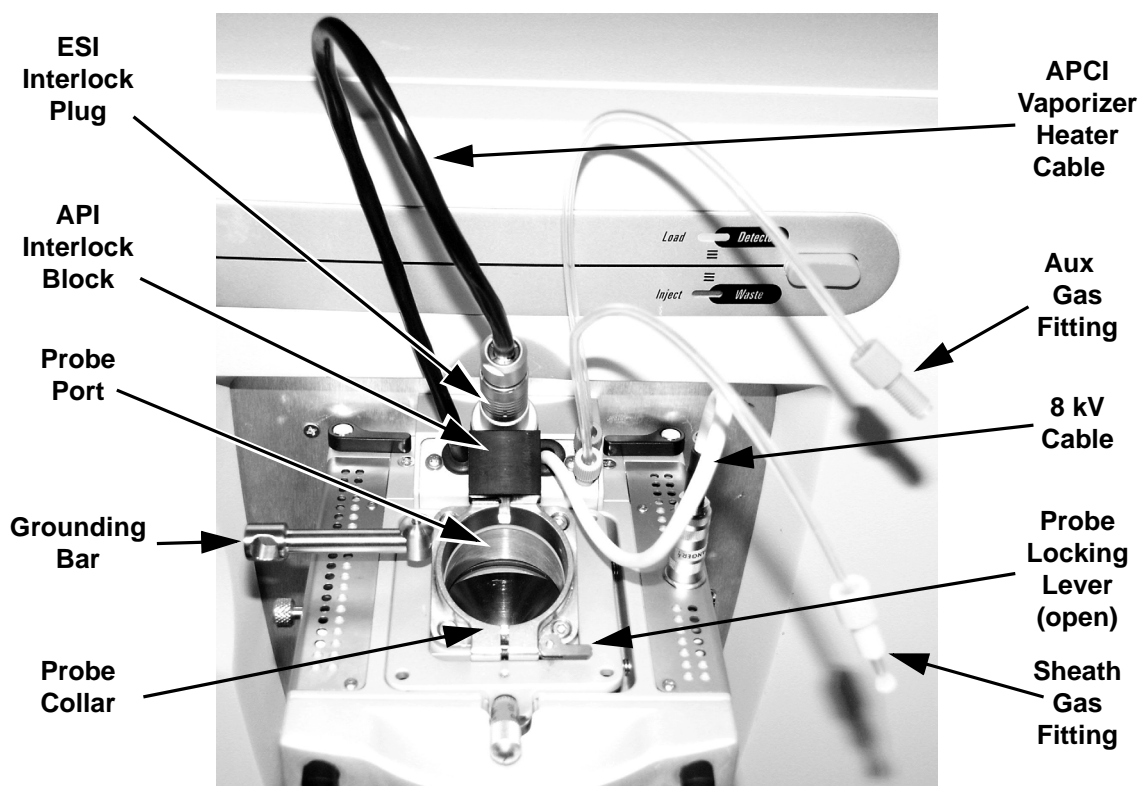

Figure 2-9. Ion Max ion source housing, probe locking lever open

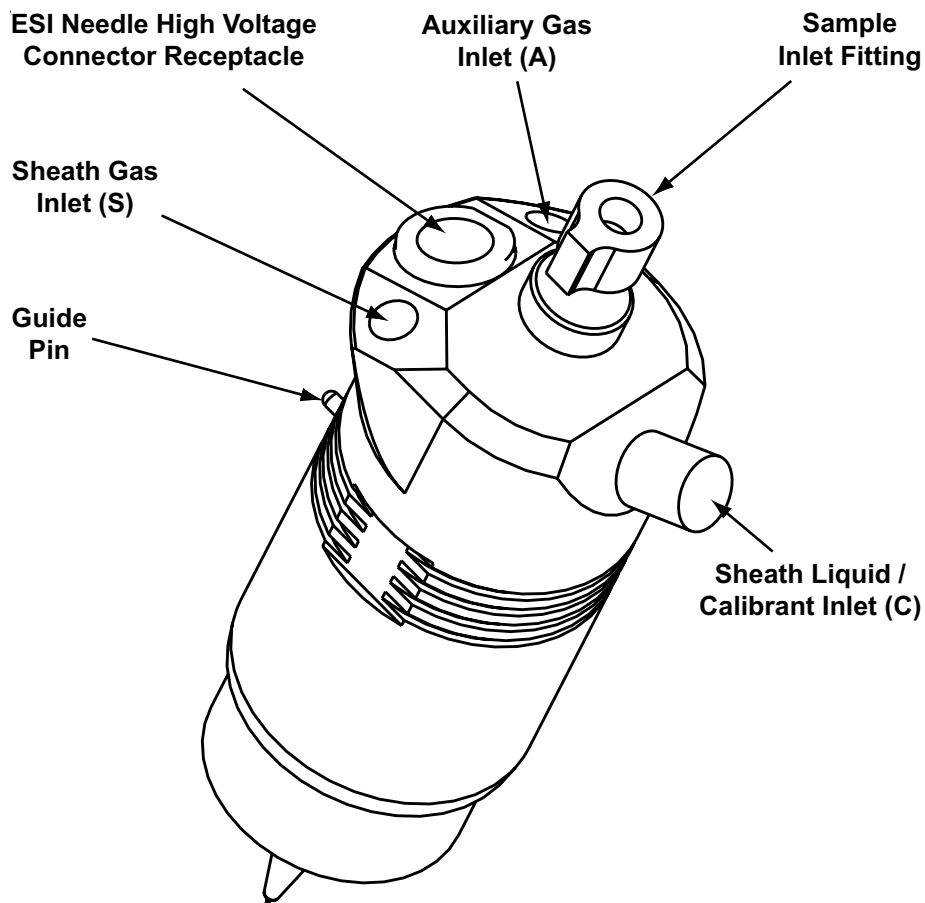

Figure 2-10. ESI probe, side view

4. Push the probe into the port until the guide pin meets with the probe collar on the ion source housing.
5. Turn the probe 45 degrees clockwise and align the guide pin with the slot in the API interlock block (you might need to pull the probe towards you slightly to properly align the pin with the notch). Once you have turned the probe far enough to align the pin with the alignment notch at the rear of the port, push the probe straight in until the guide pin stops at the bottom of the alignment notch.
6. Lock the probe in place by rotating the probe locking lever towards the front of the housing; closing the probe locking lever towards the rear of the ion source housing might make it difficult to unlock. You might first need to tighten the locking lever threaded shaft by rotating it clockwise a few turns if rotating the lever does not tighten the probe collar enough.
7. Insert the APCI vaporizer heater cable into the API interlock socket.
8. Insert the stainless steel ZDV fitting (grounding union) into the grounding bar on the ion source housing. See Figure 2-11.

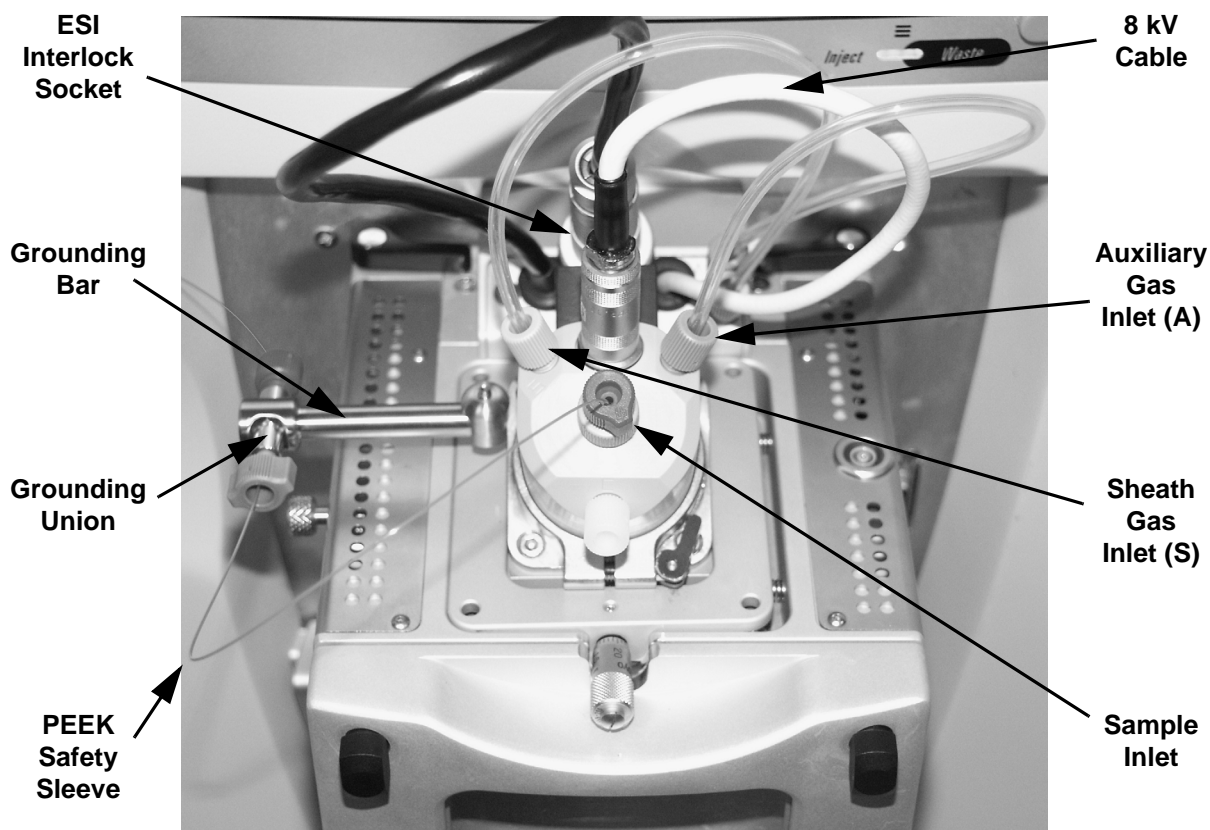

Figure 2-11. Ion Max ion source housing with ESI probe installed

9. Connect the sheath gas fitting (blue) to the sheath gas inlet (S) on the probe. (See Figure 2-11.)
10. Connect the auxiliary gas fitting (green) to the auxiliary gas inlet (A) on the probe. (Figure 2-11.)
11. Connect the 8 kV cable to the ESI needle high voltage receptacle on the ESI probe. Tighten the locking ring on the 8 kV connector.
12. Connect the sample transfer tubing to the grounding union.

The ESI probe is now properly installed in the Ion Max ion source housing.

Leave the LC/MS system in Standby and go to the next chapter: **Tuning and Calibrating the MS detector in ESI/MS/MS Mode.**

Chapter 3

Tuning and Calibrating Automatically in the ESI/MS Mode

This chapter provides information on how to tune and calibrate the Finnigan LTQ MS detector in the ESI/MS mode. For most applications, you tune and calibrate in the ESI mode through automatic procedures. The procedures use a calibration solution that is introduced into the MS detector in low flow mode. The procedures properly tune and calibrate the MS detector for ESI operation. (Refer to Table 1-2 on page 1-2.) You need to calibrate the MS detector every one to three months of operation for optimum performance over the entire mass range of the detector.

To tune and calibrate your MS detector automatically in the ESI/MS mode, you do the following:

- Infuse a low concentration calibration solution containing caffeine, MRFA, and Ultramark 1621 into the ESI source by using the syringe pump. (Refer to the topic: **Setting Up the Syringe Pump for Tuning and Calibration.**)
- Test the efficiency and stability of the spray of calibration solution into the MS detector. You can observe the following singly-charged, positive ions for caffeine, MRFA, and Ultramark 1621 in the Tune Plus window: m/z 195, 524, 1222, 1522, and 1822.
- Tune the MS detector from the Tune Plus window to optimize automatically the lenses.
- Calibrate the MS detector to adjust automatically the voltages of the linear trap.

This chapter contains the following topics:

- Setting Up the Syringe Pump for Tuning and Calibration
- Setting Up the MS Detector in the Xcalibur Data System for Tuning and Calibration
- Testing the Operation of the MS Detector in the ESI/MS Mode
- Tuning the MS Detector Automatically in the ESI/MS Mode
- Saving Your ESI/MS Tune Method
- Calibrating the MS Detector Automatically
- Cleaning the MS Detector after Tuning and Calibrating

3.1 Setting Up the Syringe Pump for Tuning and Calibration

You introduce tuning and calibration solution into the API source with a syringe infusion pump. A syringe pump allows you to infuse a sample solution into the API source for extended periods of time.

The syringe pump and syringe are located on the front panel of your Finnigan LTQ MS detector. To infuse solution for tuning and calibration, you install on the pump a 500- μ L Unimetrics[®] syringe containing the calibration solution.

Note. To minimize the possibility of cross-contamination, use a different syringe and section of fused silica tubing for the calibration solution than you do for your sample solution.

Set up the syringe pump for infusion as follows:

1. Connect a 4 cm (1.5 in.) segment of Teflon[®] tube with a (brown) fingertight fitting and a (brown) ferrule to the (black) LC union. See Figure 3-1.

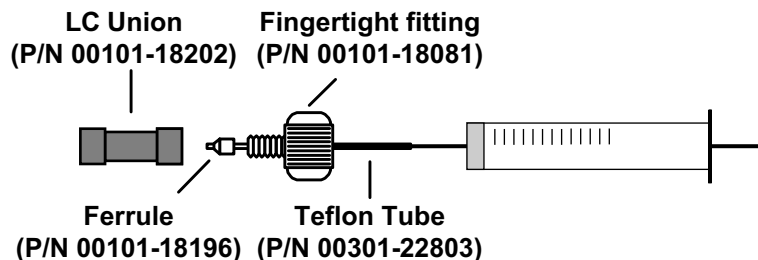

Figure 3-1. Plumbing connections for the syringe

2. Load a clean, 500- μ L Unimetrics syringe with 450 μ L of the calibration solution. (Refer to **Appendix A: Sample Formulations** for a procedure for making the calibration solution.)
3. Insert the syringe needle into the segment of Teflon tube.
4. Place the syringe into the syringe holder of the syringe pump.
5. While squeezing the blue release button on the syringe pump handle, push the handle forward until it just contacts the syringe plunger.

6. Connect a fused-silica infusion line from the LC union to the (stainless steel) grounding union as follows. See Figure 3-2.
 - a. Connect the infusion line with a (brown) fingertight fitting and a (brown) ferrule to the free end of the LC union.
 - b. Connect the other end of the infusion line with a (red) fingertight fitting and a (brown) ferrule to the grounding union.

The syringe pump is now properly set up for infusing solution into the MS detector.

Go to the next topic: **Setting Up the MS Detector in the Xcalibur Data System for Tuning and Calibration.**

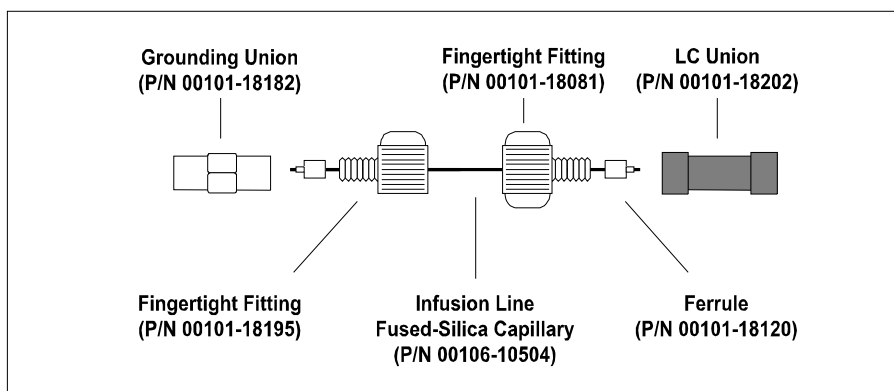

Figure 3-2. ESI/MS plumbing connections for the fused-silica infusion line

3.2 Setting Up the MS Detector in the Xcalibur Data System for Tuning and Calibration

You first tune manually with calibration solution to establish a stable spray of solution and to ensure that enough ions are detected to calibrate the MS detector. You then calibrate the MS detector automatically to optimize the parameters that affect ion detection. With the optimized MS detector, the Xcalibur data system can isolate and fragment ions and determine their mass-to-charge ratios. Perform a calibration periodically, every one to three months, for optimum performance of the MS detector.

Note. The following procedures assume that you are familiar with your Finnigan LTQ instrument and the Tune Plus window. If you need additional guidance, refer to: Finnigan LTQ online Help, **Finnigan LTQ Getting Connected**, and/or the **Finnigan LTQ Hardware Manual**.

CAUTION. Before you begin normal operation each day, ensure that you have sufficient nitrogen for your API source. If you run out of nitrogen, the Finnigan LTQ MS detector automatically turns Off to prevent the possibility of atmospheric oxygen from entering the ion source. The presence of oxygen in the ion source when the MS detector is On could be unsafe. (In addition, if the Finnigan LTQ MS detector automatically turns Off during an analytical run, you could lose data.)



Use the following procedure to set up the MS detector in the Xcalibur data system for tuning and calibration in the ESI/MS mode:

1. If you have not already done so, open the Tune Plus window from the Start button on your Windows XP task bar, as follows:
 - a. Choose **Start > Programs > Xcalibur > Xcalibur** to display the Xcalibur Home Page – Roadmap view.
 - b. Click on the Instrument Setup button to display the Instrument Setup window.
 - c. Click on the Finnigan LTQ button to display the New Method page.

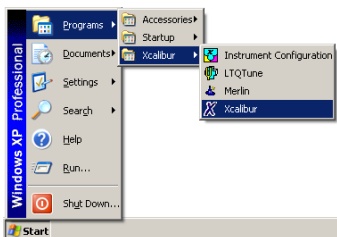

Finnigan LTQ _____ Setting Up the MS Detector in the Xcalibur Data System for Tuning and Calibration

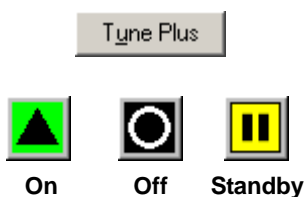

d. Click on the Tune Plus button to display the Tune Plus window. See Figure 3-3.

2. In the Tune Plus window, on the Control/Scan Mode toolbar, click on the On/Standby button to take the MS detector out of the Standby (or Off) mode and turn it On. When you turn the MS detector to On, you initiate the following events:

- The MS detector begins scanning.
- Nitrogen flows into the ESI probe.
- The Finnigan LTQ MS detector applies high voltage to the ESI probe.
- The Xcalibur data system shows a real-time display in the Spectrum view.

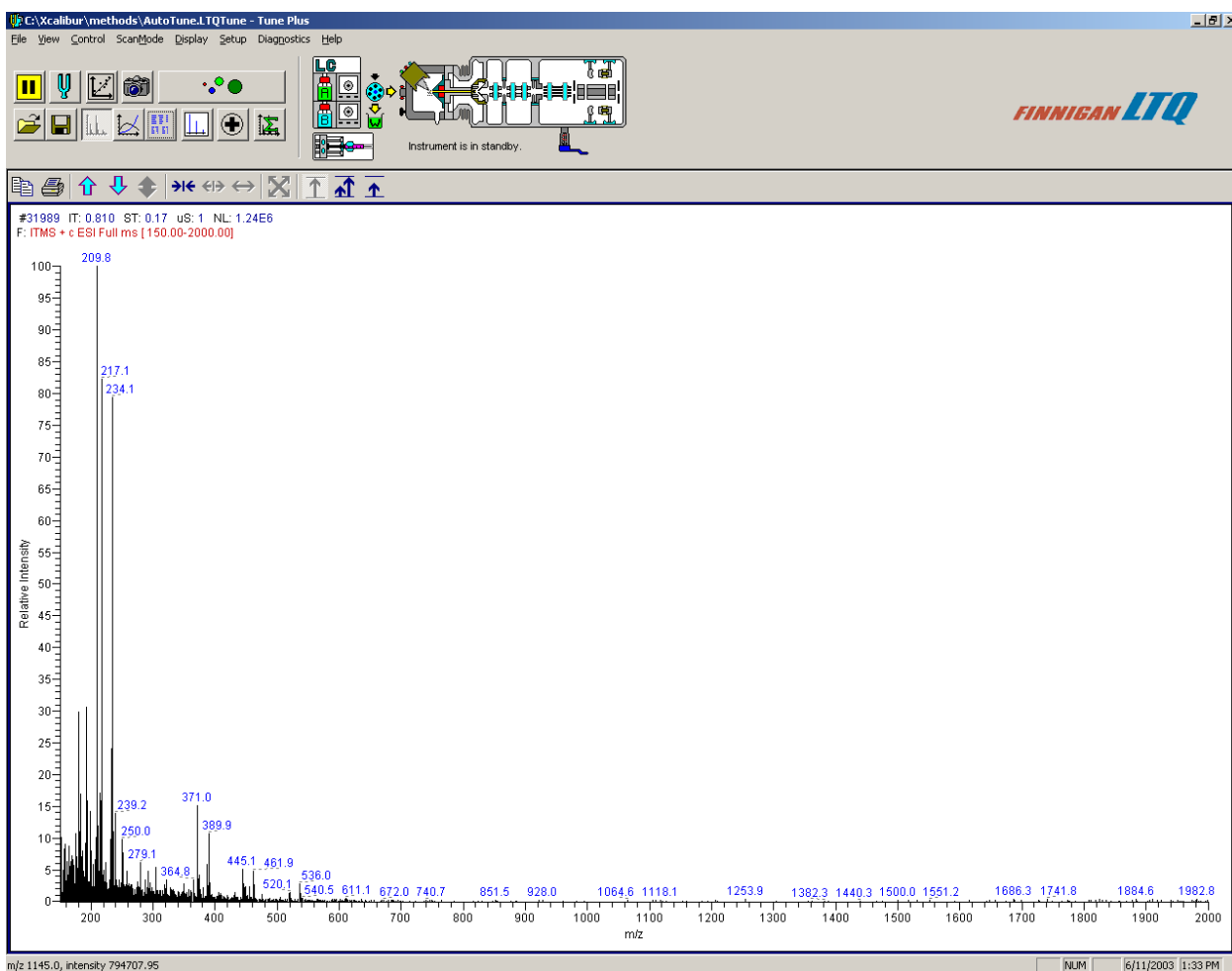

Figure 3-3. Tune Plus window, showing the MS detector in the Standby mode

Note. The Xcalibur data system contains customized tune files for different applications in the folder *C:\Xcalibur\methods*, including one for low flow LC/ESI/MS operation.

3. Open the Tune Method file that stores the factory default tune settings for low-flow ESI operation, as follows:
 - a. Choose **File > Open** to display the Open dialog box.
 - b. Browse for the folder *C:\Xcalibur\methods*. Then, select the file *AutoTune.LTQTune*.
 - c. Click on **Open** to open the file. Tune Plus downloads the Tune Method parameters to the MS detector.
4. Examine the pre-tune ESI source settings as follows:
 - a. From the Instrument Setup toolbar, click on the API Source button to open the ESI Source dialog box. Verify that the settings in your dialog box are the same as those shown in Figure 3-4.
 - b. Click on **OK** to return to the Tune Plus window.

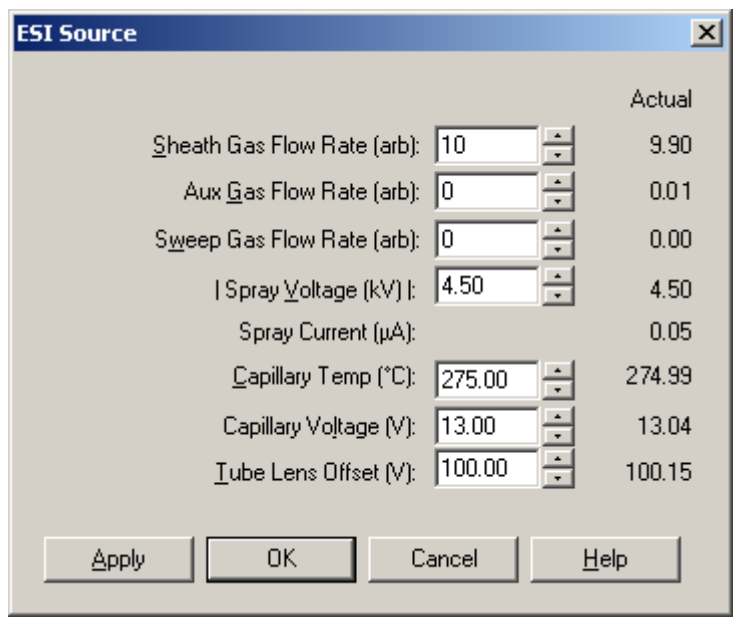
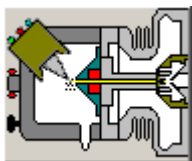

Figure 3-4. ESI Source dialog box, showing the settings to start a typical low flow experiment

5. Set the scan parameters for tuning and calibration, as follows:



- a. On the Control/Scan Mode toolbar, click on the Define Scan button to open the Define Scan dialog box. See Figure 3-5. (If your dialog box appears different from the one shown in the figure, it is probably because the advanced settings are not displayed. You can turn on the advanced settings as follows: In Tune Plus, choose **ScanMode**, and then click on *Advanced Scan Features* to select the option.)
- b. In the Scan Description group box, in the Mass Range list box, select *Normal* to allow for a selection of mass ranges between m/z 150 to 2000.
- c. In the Scan Rate list box, select *Normal* to specify a normal scan rate.
- d. In the Scan Type list box, select *Full* to specify a full scan.
- e. In the Scan Time group box, in the Microscans spin box, enter **1** to set the total number of microscans to 1.
- f. In the Max. Inject Time spin box, enter *200.000* to specify a 200 ms maximum injection time.
- g. In the Source Fragmentation group box, confirm that the On check box is not selected () to specify that the ion source fragmentation option is turned off.
- h. In the Scan Ranges group box, in the Input list box, select *From/To* to make available the First Mass and Last Mass text boxes in the Scan Ranges table.

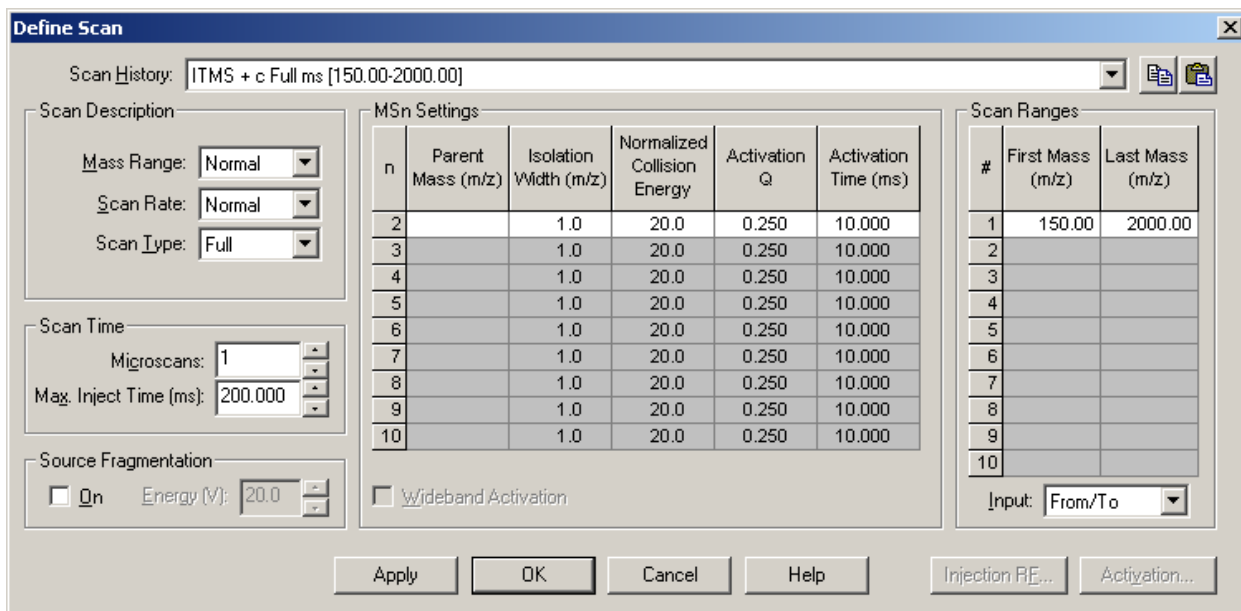

Figure 3-5. Define Scan dialog box, showing the default settings for ESI/MS operation

- i. In the Scan Ranges group box, in the Scan Ranges table, in the First Mass text box, enter **150** to set the first mass for the scan range to m/z 150.
- j. In the Last Mass text box, enter **2000** to set the last mass for the scan range to m/z 2000.
- k. Ensure that the settings in your Define Scan dialog box are the same as those shown in Figure 3-5.
- l. Click on **OK** to apply the MS detector scan parameters and to close the Define Scan dialog box.



6. On the Control/Scan Mode toolbar, click on the Centroid/Profile button to toggle the data type to profile. (The picture on the button should be the same as that shown here.)



7. Click on the Positive/Negative button to toggle the ion polarity mode to positive. (The picture on the button should be the same as that shown here).

The MS detector is now properly set up in the Xcalibur data system for tuning and calibration in the ESI/MS mode.

Go to the next topic: **Testing the Operation of the MS Detector in the ESI/MS Mode.**

3.3 Testing the Operation of the MS Detector in the ESI/MS Mode

You are now ready to test if your MS detector is operating properly. To test for proper operation, you infuse the calibration solution into the ESI source, and then you monitor the real-time display of the mass spectrum of calibration solution. You want to ensure that a stable spray of solution enters the MS detector.

Test the operation of the MS detector in the ESI/MS mode, as follows:



1. Click on the Syringe Pump button to display the Syringe Pump dialog box. See Figure 3-6.

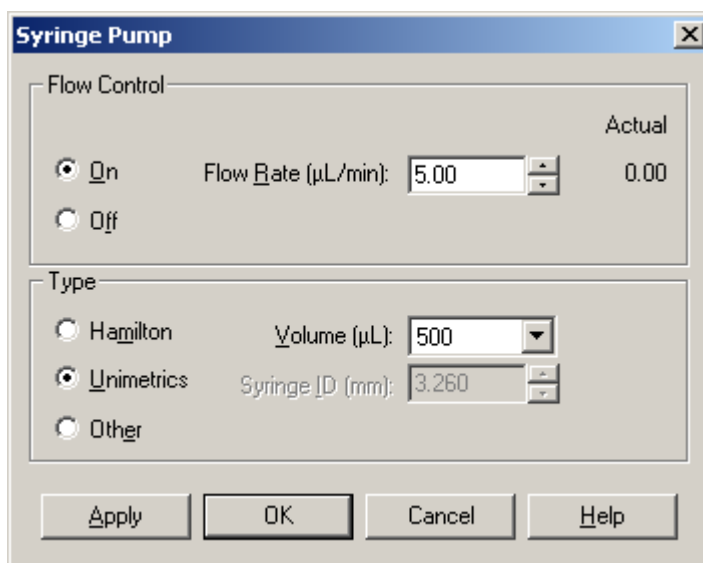

Figure 3-6. Syringe Pump dialog box

2. Turn on the syringe pump and set an infusion flow rate of 5 µL/min, as follows:
 - a. In the Flow Control group box, click on the On option button to make active the Flow Rate spin box.
 - b. Enter 5 in the Flow Rate spin box to specify a rate of 5 µL/min.

Note. This procedure assumes that you are using the 500-µL Unimetrics syringe that is provided with your Finnigan LTQ system. If you are using another type of syringe, select the option button corresponding to your syringe.

- c. If you are using a standard Unimetrics (or Hamilton) syringe, set up the syringe parameters as follows:
 - i. In the Type group box, click on the Unimetrics (or Hamilton) option button to specify the proper syringe type.
 - ii. Click on the Volume list box arrow to display the list of available volumes, and then select 500 (or your syringe size) from the list to set the proper syringe volume. Note that, if you are using a Unimetrics syringe, the Finnigan LTQ MS detector automatically sets the syringe ID to its proper value of 3.260 mm.
- d. If you are not using a Unimetrics (or Hamilton) syringe, set up the syringe parameters as follows:
 - i. In the Type group box, click on the Other option button to make active the syringe ID spin box.
 - ii. Enter the inner diameter of your syringe in the Syringe ID spin box.
- e. Click on **OK** to apply the syringe parameters, start the syringe pump, and close the Syringe Pump dialog box.



3. On the File/Display toolbar, click on the Display Spectrum View button to ensure that the Spectrum view is displayed.
4. Monitor the data for the calibration solution, as follows:
 - a. In the Spectrum view of the Tune Plus window, observe the mass spectra of the singly-charged ions of calibration solution. The ions are as follows. See Figure 3-7.
 - Caffeine: m/z 195
 - MRFA: m/z 524
 - Ultramark 1621: m/z 1022, 1122, 1222, 1322, 1422, 1522, 1622, 1722, 1822

Note. Based on the LC flow rate of your experiment, you can specify the value of each of the following tuning parameters on the Finnigan LTQ MS detector: sheath, Auxiliary, and Sweep gas pressures, ESI needle (or “spray”) voltage, ion transfer capillary temperature, and probe position. Automatic tuning sets the values of the other parameters.

- b. At the top of the Spectrum view, notice the values for the ionization time (IT) and normalization level (NL). See Figure 3-7.
- c. Click on the API Source button to open the ESI Source dialog box. (See the Spray Current readback shown in Figure 3-4.)
- d. Observe the value for the Spray Current readback and the values for NL and IT in the Spectrum view. As calibration solution infuses, and

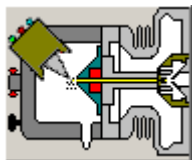

the readback values fluctuate, ask yourself the following questions about the ion current signal:

- Is the signal present?
- Is the signal stable, varying by less than about 15% from scan to scan?

If you answered “yes” to the questions in step 4.d, then your MS detector is operating properly.

If you answered “no” to either of these questions, try the following troubleshooting measures:

- Ensure that the fused-silica sample tube does not extend beyond the tip of the ESI needle.
- Ensure that the entrance to the ion transfer capillary is clean, and is not covered with a piece of septum.
- Ensure that the solution entering the probe is free of air bubbles and that the tubing and connectors are free of leaks.

Congratulations! You have demonstrated that your MS detector is operating properly in the ESI mode. You are now ready to tune and calibrate the MS detector. Leave your Finnigan LTQ MS detector as it is, and go to the next topic: **Tuning the MS Detector Automatically in the ESI/MS Mode.**

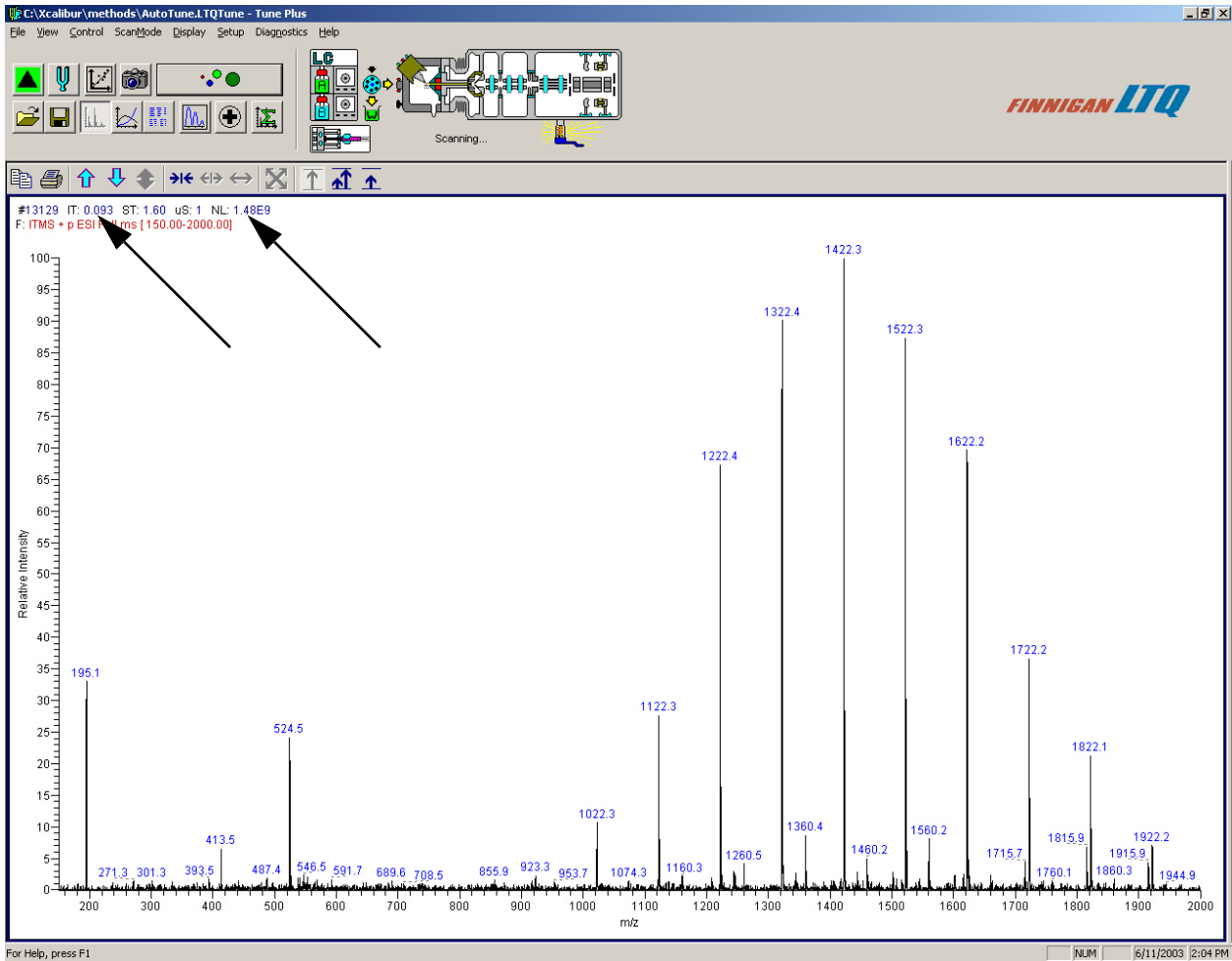

Figure 3-7. Spectrum view of the Tune Plus window, showing ionization time (IT) and normalization level (NL) of calibration solution

3.4 Tuning the MS Detector Automatically in the ESI/MS Mode

You tune the MS detector automatically in the ESI/MS mode to optimize important parameters, including heated capillary voltage and tube lens voltage.

Use the following procedure to tune the MS detector automatically:



1. On the Control/Scan Mode toolbar, click on the Tune button to display the Tune dialog box.
2. If necessary, click on the Automatic tab to display the Automatic tuning page. See Figure 3-8.
3. In the What to Optimize On group box, select the Mass option button to make active the Mass spin box.

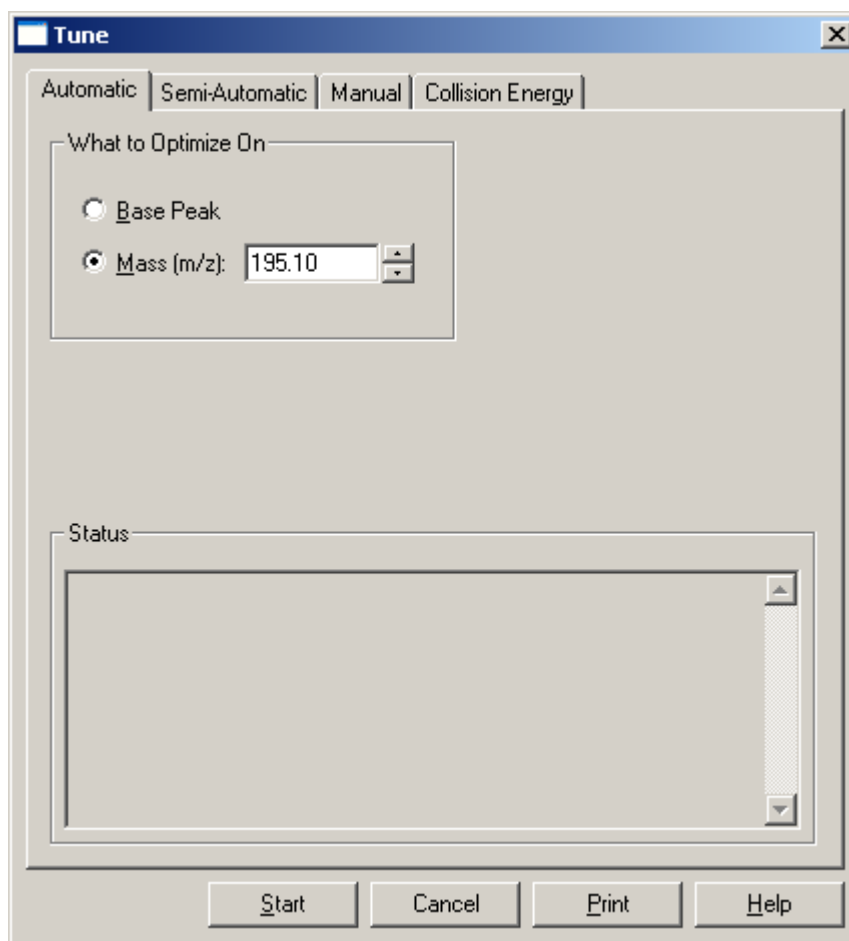

Figure 3-8. Tune dialog box, showing the Automatic tuning page

4. In the Mass spin box, enter **195.1** to specify that the Finnigan LTQ MS detector optimize your Tune Method on the peak at m/z 195.1.

Note. In this example, you use the mass peak at m/z 195.1 to optimize the Tune Method. However, you can optimize the tune on any mass peak of the calibration solution.

5. Start the automatic tuning procedure, as follows:
 - a. Click on **Start**. A message box displays the following message:
Please ensure that the 500 microliter syringe is full.
Ensure that the syringe contains at least 450 μ L calibration solution.
 - b. Click on **OK** to close the message box, and return to the Tune dialog box.



6. On the File/Display toolbar, click on the Graph View button to display the Graph view. See Figure 3-9.
7. Observe the Tune Plus window and the Tune dialog box. While automatic tuning is in progress, the Finnigan LTQ MS detector displays various tests in the Spectrum and Graph views in Tune Plus and displays various messages in the Status group box in the Tune dialog box. Your Tune Plus window should now look similar to the one shown in Figure 3-9.
8. Click on the ESI Source dialog box to examine the ESI source parameters after tuning. Compare the settings shown in Figure 3-10 with the pre-tune settings shown in Figure 3-4 on page 3-6.

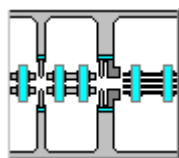

9. Click on the Ion Optics toolbar button to display the Ion Optics dialog box. The parameters in the Ion Optics dialog box are optimized automatically by the Finnigan LTQ MS detector. See Figure 3-11.

You have now successfully tuned the MS detector in ESI/MS mode using the calibration solution. Go to the next topic: **Saving Your ESI/MS Tune Method**.

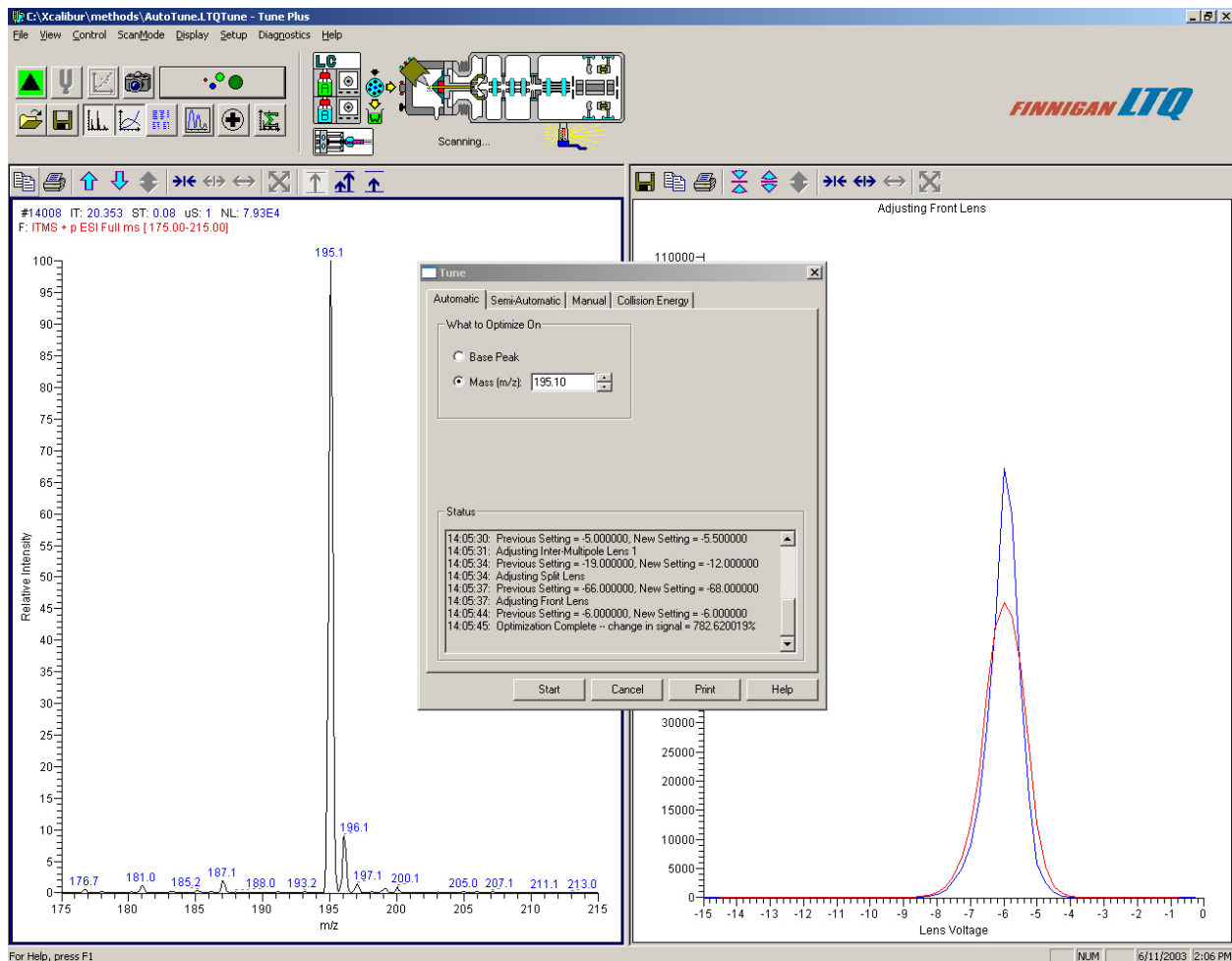

Figure 3-9. Tune Plus window, showing the results of a typical automatic tune procedure

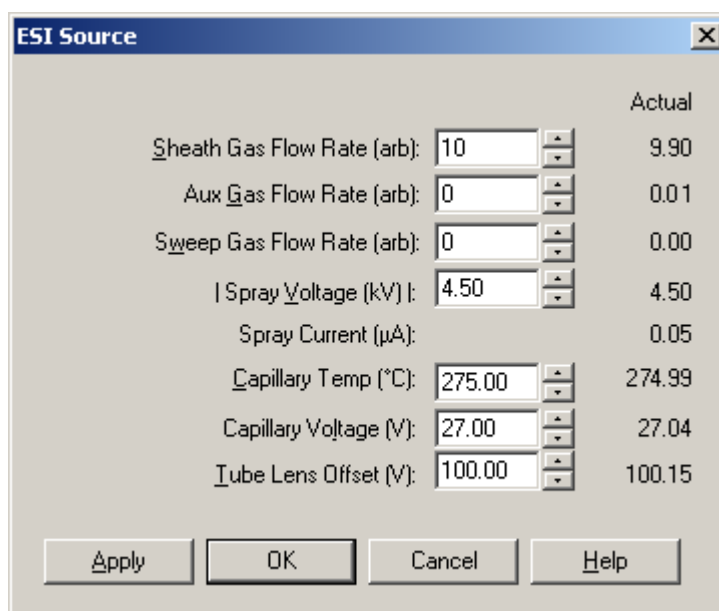

Figure 3-10. ESI Source dialog box, showing typical parameters after automatic tuning

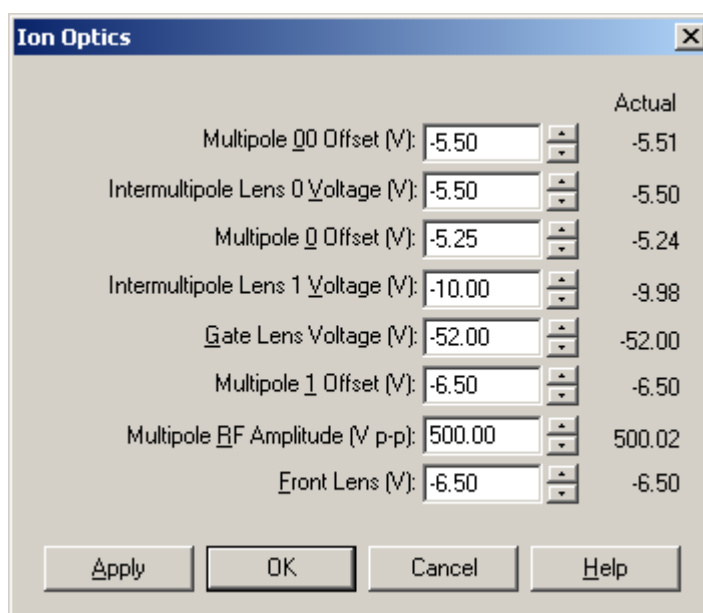

Figure 3-11. Ion Optics dialog box, showing examples of voltages of lenses and Intermultipoles, which are optimized by the Finnigan LTQ automatic tuning procedure

3.5 Saving Your ESI/MS Tune Method

You can save the parameters you just set in a Tune Method specific to your particular analyte and solvent flow rate. (In this case, you save settings obtained using calibration solution.) You can recall the Tune Method and use it as a starting point for optimizing the MS detector on a different analyte of interest or at a different flow rate.

Note. You must save the Tune Method while the MS detector is On.

Save your ESI/MS Tune Method (for low-flow operation) when automatic tuning is complete, as follows:

1. Choose **File > Save As** to display the Save As dialog box. See Figure 3-12.

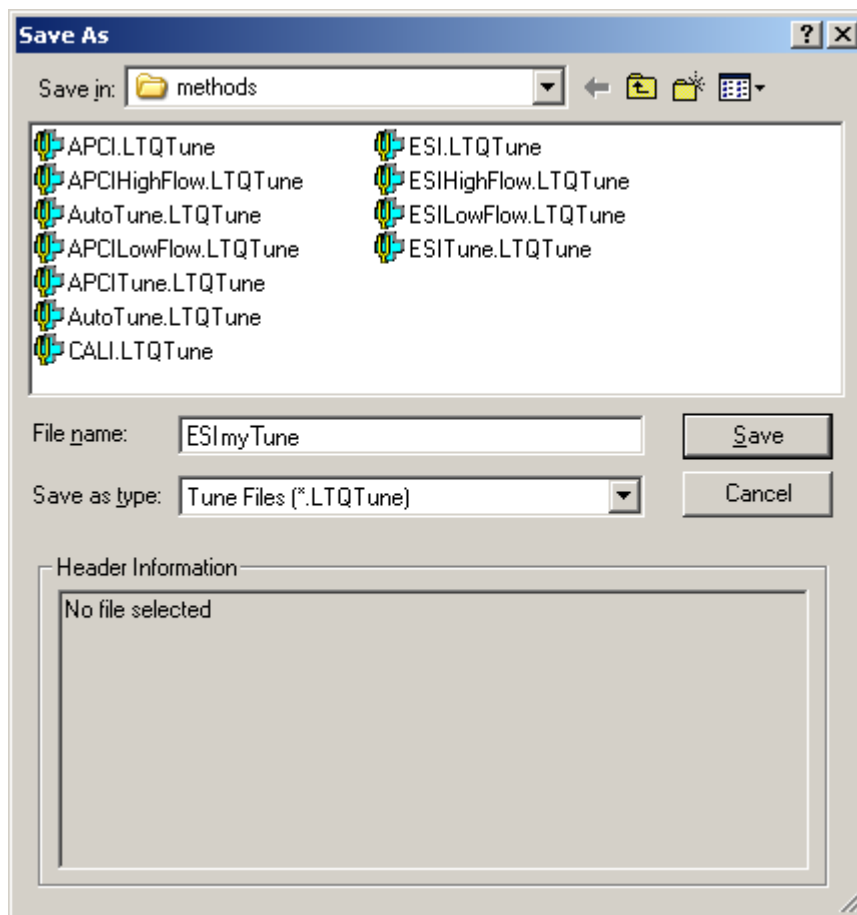

Figure 3-12. Save As dialog box, showing files in the folder *C:\Xcalibur\methods*

2. Select the *C:\Xcalibur\methods* folder.
3. Click on the File Name text box, and then enter **ESImyTune** to name the Tune Method *ESImyTune.LTQTune*.
4. Click on **Save** to save the Tune Method, and return to the Tune Plus window. Note that the Tune Method is named *ESImyTune.LTQTune*.

Once you have tuned the MS detector, you are ready to calibrate. Go to the next topic: **Calibrating the MS Detector Automatically**.

3.6 Calibrating the MS Detector Automatically

Use the following procedure to calibrate the MS detector automatically from the Tune Plus window:

1. Choose **Control > Calibrate** to display the Calibrate dialog box.
2. If necessary, click on the Automatic tab to display the Automatic calibration page. See Figure 3-13.

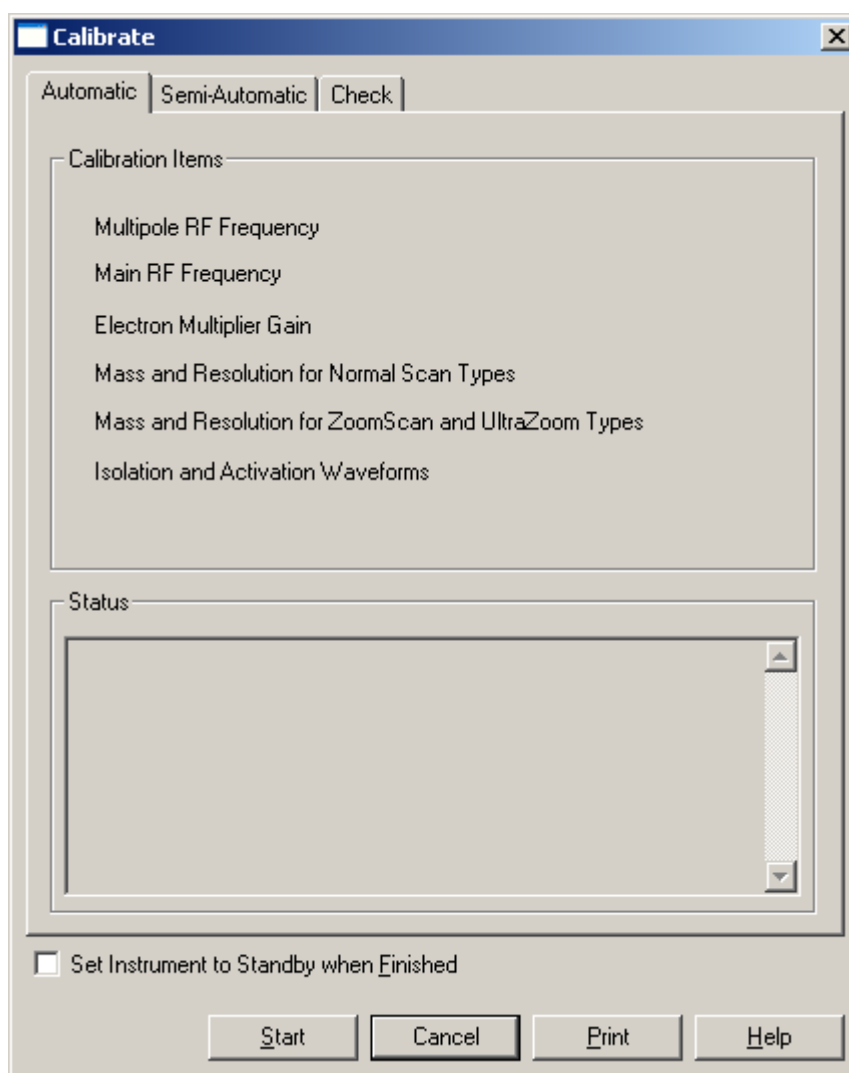

Figure 3-13. Calibrate dialog box, showing the Automatic calibration page

3. Start the automatic calibration procedure, as follows:
 - a. Click on **Start**. A message box displays the following message:
Please ensure that the 500 microliter syringe is full.
Ensure the syringe contains at least 450 μ L calibration solution.
 - b. Click on **OK** to close the message box, and return to the Calibrate dialog box.
4. Observe the Tune Plus window and the Calibrate dialog box. While the automatic calibration is in progress, the Finnigan LTQ MS detector displays a variety of test results in the Spectrum and Graph views and displays a variety of messages in the Status box of the Calibrate dialog box.

The automatic calibration procedure typically takes about 40 min.

When the Finnigan LTQ MS detector completes the calibration procedure it restores the full scan ESI mass spectrum in the Spectrum view. The Instrument Messages dialog box is displayed, which indicates whether or not the calibration procedure for an item is successful.

- If a calibration item is successful, the Finnigan LTQ MS detector saves the new calibration parameter automatically to the hard disk.
- If a calibration item fails, you can try calibrating on that item again after you ensure the following: the spray is stable, the solution flow rate is sufficient, and all the ions in the calibration solution are present with adequate signal-to-noise ratios. If the sensitivity of the ions is low, increase the solution flow rate somewhat, and then use the *semi-automatic* calibration procedure to calibrate the specific parameter that failed. See Figure 3-14. Consider deselecting the ZoomScan Mode option if repeated failures occur.

When all calibration items are successful, your MS detector is properly tuned and calibrated for low-flow experiments. A successful calibration exhibits adequate intensities of the following calibrant ions: m/z 195, 524, 1222, 1522, and 1822. In many cases, fine tuning on your particular analyte is not necessary if the intensity of these ions is sufficient.

You are ready to analyze samples if you do not need to maximize the intensity of the ion signals for your analyte.

In **Chapter 4: Optimizing the MS Detector Tune Automatically with Your Analyte**, you change the solution flow rate and optimize the MS detector parameters on reserpine or on your particular analyte.

Before you tune with your analyte, go to the next topic: **Cleaning the MS Detector after Tuning and Calibrating**.

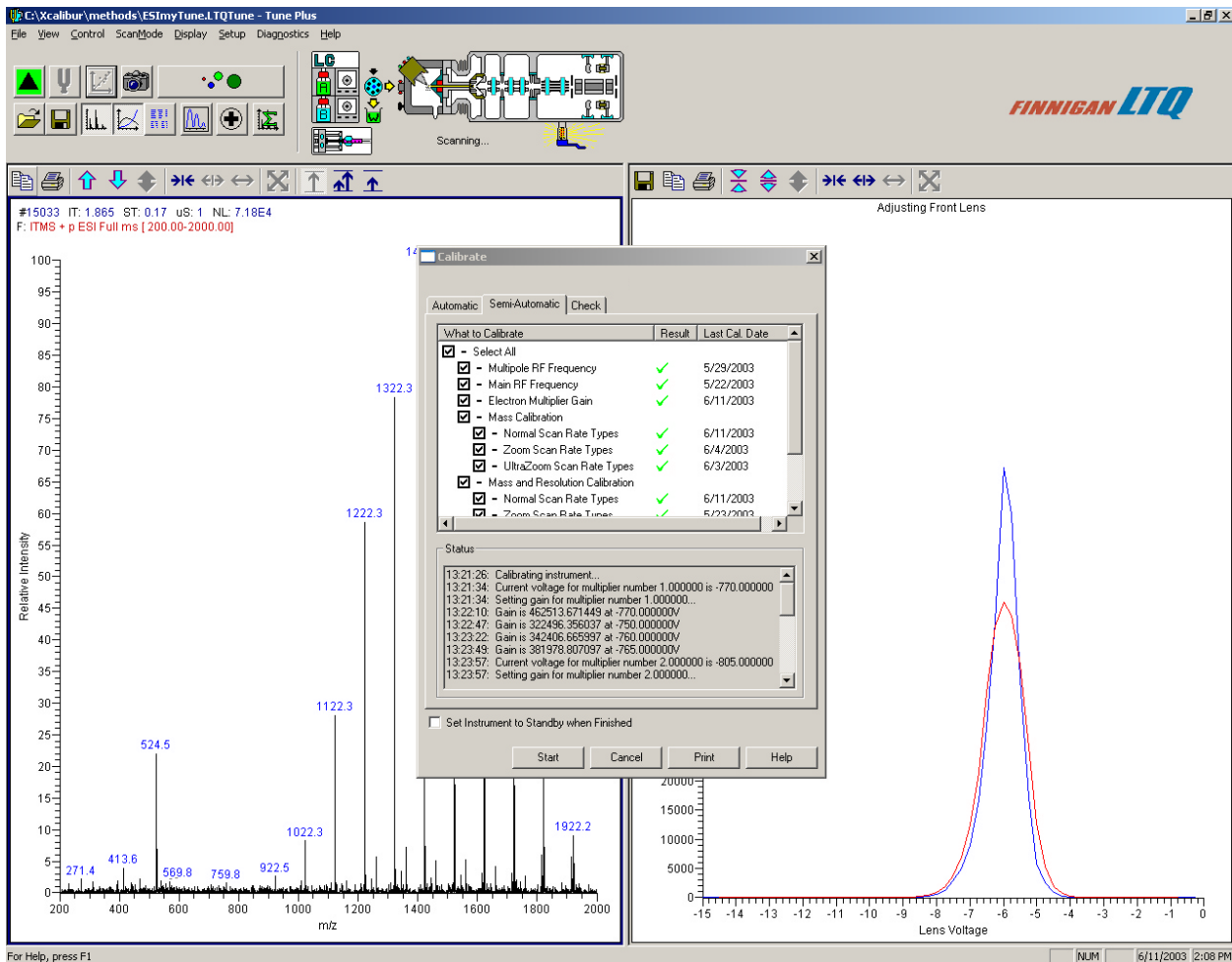

Figure 3-14. Tune Plus window with Calibrate dialog box, showing the results of a successful semi-automatic calibration procedure

3.7 Cleaning the MS Detector after Tuning and Calibrating

This topic describes how to clean your MS detector after using the calibration solution, in preparation for acquiring data on your analyte of interest.

Use the following procedure to clean the MS detector after calibrating:



On



Standby



1. Click on the On/Standby button to put the MS detector in Standby mode. When the MS detector is in Standby, the Finnigan LTQ MS detector turns off the sheath gas, Auxiliary gas, Sweep gas, ESI high voltage, and syringe pump. The MS detector stops scanning, and the Finnigan LTQ MS detector freezes the displays for the Spectrum and Graph views.

CAUTION. Always place the MS detector in Standby (or Off) before you open the API source to atmospheric oxygen. The presence of oxygen in the ion source when the MS detector is On could be unsafe. (The Finnigan LTQ MS detector automatically turns the MS detector Off when you open the API source, however, it is best to take this added precaution.)

2. Remove the syringe from the syringe pump holder, as follows:
 - a. Squeeze the blue buttons, and pull back on the syringe pump handle to free the syringe.
 - b. Remove the syringe from the holder.
 - c. Disconnect the tip of the syringe needle from the Teflon tubing.
3. Clean the syringe thoroughly, as follows:
 - a. Clean the syringe with a solution of 5% formic acid in water.
 - b. Rinse the syringe with a solution of 50:50 methanol:water.
 - c. Use acetone to rinse the syringe. (Repeat this step several times.)
4. To gain access to the ion transfer capillary, the Ion Max ion source housing and the ion sweep cone need to be removed. Refer to the topic **Removing the Ion Max Ion Source Housing** on page 2-6 for instructions for removing the Ion Max ion source housing.

5. Remove the ion sweep cone as follows:
 - a. Put on a pair of talc-free gloves.



CAUTION. AVOID BURNS. At operating temperatures, the ion transfer tube can severely burn you! The ion transfer tube typically operates between 200 and 400 °C. **Always allow the ion sweep cone to cool to room temperature (for approximately 20 min) before you touch or remove this component.** Always be careful not to touch the entrance end of the ion transfer tube when it is exposed.

- b. Grasp the outer ridges of the ion sweep cone and pull the cone straight off of the API cone seal. Note, you might need to loosen the set screws on the ion sweep cone in order to remove it.
6. Remove the ion transfer capillary by using the custom tool provided.
7. Clean the ion sweep cone and the ion transfer capillary as follows:
 - a. Place the ion sweep cone and the ion capillary tube in a beaker of 50:50 methanol/water.
 - b. Sonicate the components for 15 min.
8. Reinstall the ion transfer capillary.
9. Reinstall the ion sweep cone as described in topic **Installing the Ion Sweep Cone** on page 2-7.
10. Place a small Teflon coated septum over the entrance end of the ion transfer capillary to seal the vacuum chamber of the MS detector.
11. Flush the sample transfer line, sample tube, and ESI probe thoroughly with a solution of 5% formic acid in water (or with another appropriate solvent), as follows:

Note. The solvent that you use to flush the sample transfer line, sample tube, and ESI probe assembly depends on the solvent system you use to dissolve your samples. For example, if you are using a buffered solution of a high concentration, an acidic solution is appropriate.

- a. Fill a clean, 250 µL Unimetrics syringe with a solution an appropriate solvent.
 - b. While holding the plunger of the syringe in place, carefully insert the needle of the syringe into the free end of the Teflon tube.
 - c. Flush the sample transfer line, sample tube, and ESI probe with the solution by slowly depressing the syringe plunger. Visually check that the solution is exiting the tip of the ESI probe on the inside of the probe assembly. Use a lint-free tissue to gently remove the excess solution as it exits the probe.
 - d. Remove the needle of the syringe from the Teflon tube.

12. Repeat step 11 with a solution of 50:50 methanol:water.
13. Repeat step 11 with acetone.
14. Clean the spray shield as follows:
 - a. Fill a spray bottle with solvent solution.
 - b. Temporarily place a large Kimwipe (or other lint-free tissue) beneath of the spray shield. (The Kimwipe is required to absorb the solution used to flush the ion transfer capillary and spray shield.)
 - c. Use the spray bottle to flush contaminants from the exterior surface of the spray shield.
 - d. Remove the Kimwipe you used to absorb the solution. Swab the surface of the spray shield with a dry Kimwipe.
 - e. Repeat step 14.a through step 14.d with acetone to remove the (high molecular weight) Ultramark 1621.
15. Being careful not to touch the ion transfer capillary with your hand, remove the septum from the entrance end of the ion transfer capillary.
16. Reinstall the Ion Max ion source housing as described in **Installing the Ion Max Ion Source Housing** on page 2-9.

The MS detector is now clean and ready for acquiring data on your analyte of interest.

If you plan to run analytical samples in high-flow ESI mode (using flow rates between 50 and 1000 $\mu\text{L}/\text{min}$), optimize the tune further by following the procedures in the next chapter: **Tuning with Your Analyte in LC/ESI/MS Mode**.

Chapter 4

Tuning with Your Analyte in LC/ESI/MS Mode

This chapter provides information on tuning the MS detector in the LC/ESI/MS mode using your analyte. You optimize the sensitivity of your analyte in the MS detector through an automatic procedure.

The customized Tune Methods contained in your Finnigan LTQ data system are optimized for a wide range of applications, and they can often be used without further tuning of your MS detector. However, for certain applications you might need to tune and optimize several MS detector parameters.

For instance, the most important parameters that interact with the ESI interface and signal quality are as follows:

- Electrospray voltage
- Heated capillary temperature (voltage)
- Tube lens voltage
- Capillary voltage
- Sheath gas flow rate
- Auxiliary gas flow rate
- Sweep gas flow rate

The settings for these parameters depend on the solvent flow rate and target analyte composition. In general, you should fine tune your MS detector whenever you change the solvent flow rate conditions of your particular application. In this procedure, you use the ESI low-flow Tune Method *ESImyTune.LTQTune* as a starting point, and then further optimize the MS detector parameters using an automatic procedure. The automatic procedure adjusts the tube lens voltage, capillary voltage, and voltages applied to the ion optics until the ion transmission of your analyte is maximized.

The capillary is heated to maximize the ion transmission to the MS detector. For ESI only, you set the ion transfer capillary temperature proportional to the flow rate of your solution. Refer to Table 1-2 for guidelines for setting operating parameters for LC/ESI/MS. For this procedure, the ion transfer capillary temperature is set to 350 °C, and the sheath gas is set to 30.

Note. If your experiment is performed at a flow rate below 10 $\mu\text{L}/\text{min}$, and the results you want can be obtained without optimizing the MS detector on your particular analyte, you can go to **Chapter 5: Acquiring ESI Sample Data Using the Tune Plus Window** to acquire sample data.

Note. Before you optimize the tune for your analyte of interest, ensure that the Finnigan LTQ MS detector has been calibrated within the previous three months. If the system needs to be calibrated, refer to the procedures in the **Chapter 3: Tuning and Calibrating Automatically in the ESI/MS Mode**.

To tune the MS detector in the ESI/MS (high-flow) mode using your analyte, you perform the following tasks:

- Set up the MS detector for your specific analyte from the Tune Plus window.
- Infuse your analyte into the MS detector using a syringe pump connected to the LC with a Tee union.
- Optimize the MS detector parameters for your analyte while the solution flows into the MS detector.

This chapter contains the following topics:

- Setting Up to Introduce Sample by Syringe Pump into Solvent Flow from an LC
- Setting Up to Tune the MS Detector with Your Analyte
- Optimizing the MS Detector Tune Automatically with Your Analyte
- Saving the ESI/MS Tune Method

4.1 Setting Up to Introduce Sample by Syringe Pump into Solvent Flow from an LC

This topic describes setting up the MS detector to introduce your analyte by syringe pump into solvent flow from an LC.

Make the plumbing connections for ESI/MS sample introduction from the syringe pump into solvent flow from an LC as following:

1. Connect a 4 cm (1.5 in.) segment of Teflon tubing with a (brown) fingertight fitting and a (brown) ferrule to the (black) LC union. (See Figure 3-2 on page 3-3.)
2. Fill a clean, 500- μ L Unimetrics syringe with the 125 fg/ μ L solution of reserpine or your analyte of interest. (Refer to **Appendix A: Sample Formulations** for a procedure for making the reserpine tuning solution.)
3. Insert the needle of the syringe into the segment of Teflon tube. Check that the needle tip of the syringe fits readily into the opening in the free end of the Teflon tubing. If necessary, you can enlarge the opening in the end of the tubing slightly.
4. Place the syringe into the syringe holder of the syringe pump.
5. While squeezing the blue release buttons on the syringe pump handle, push the handle forward until it just contacts the syringe plunger.
6. Connect the fused-silica infusion line from the (black) LC union to the (black) LC Tee union, as follows. See Figure 4-1.
 - a. Connect the infusion line with a (brown) fingertight fitting and a (brown) ferrule to the free end of the LC union.
 - b. Connect the other end of the infusion line with a (red) fingertight fitting and a (brown) ferrule to the side arm of the LC Tee union.
7. Connect an appropriate length of (red) PEEK tubing from the (stainless steel) grounding union to the (black) LC Tee union, as follows.
 - a. Use a PEEK tubing cutter to cut a 4 cm (1.5 in.) length of the PEEK tubing.
 - b. Connect the PEEK tubing with a (brown) fingertight fitting and a (brown) ferrule to the grounding union.
 - c. Connect the other end of the PEEK tubing with a (brown) fingertight fitting and a (brown) ferrule to the LC Tee union.

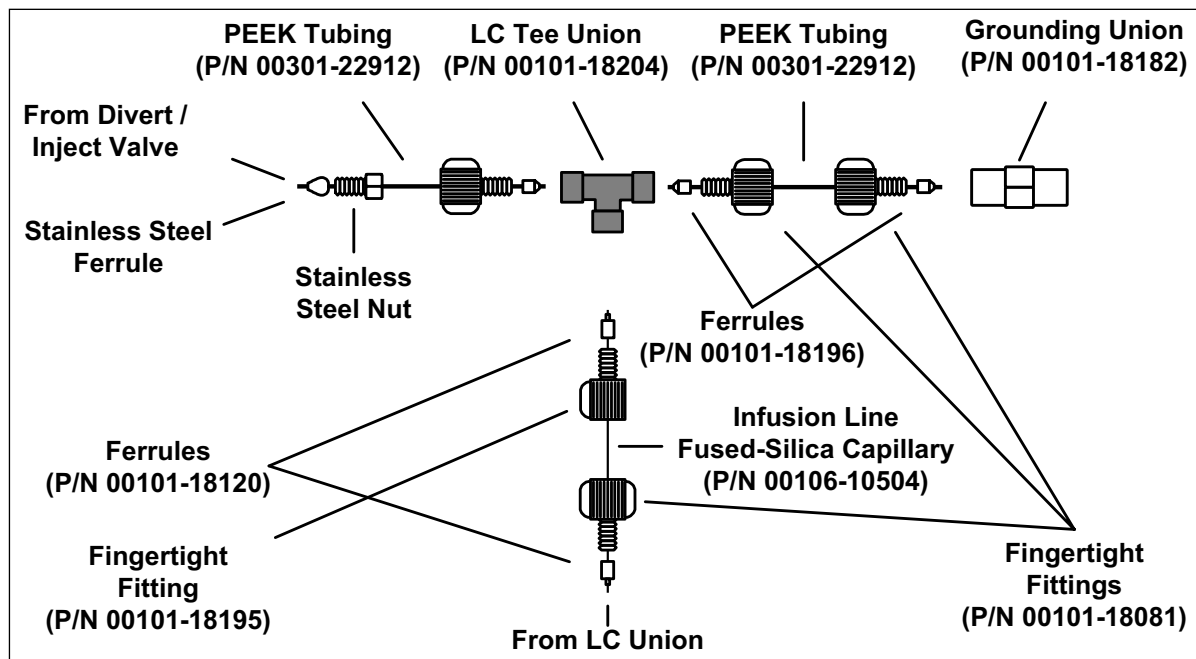

Figure 4-1. ESI/MS plumbing connections for the LC Tee union

8. If you have not already done so, connect the PEEK safety sleeve and fused-silica sample tube from the grounding union to the ESI probe sample inlet as described in the topic: **Installing a New Fused-Silica Sample Tube and PEEK Safety Sleeve** in the **Finnigan Ion Max API Source Hardware Manual**.
If you have installed the stainless steel needle in the ESI probe, connect the PEEK safety sleeve and fused-silica capillary tube from the grounding union to the ESI probe sample inlet as described in the topic: **Installing a New Stainless Steel Needle in the ESI Probe** and **Installing a New Fused-Silica Sample Tube and PEEK Safety Sleeve** in the **Finnigan Ion Max API Source Hardware Manual**.
9. Connect an appropriate length of PEEK tubing (transfer line from the divert/inject valve) from the divert/inject valve to the free end of the (black) LC Tee union, as follows.
 - a. Connect a length of PEEK tubing with a (stainless steel) nut and a (stainless steel) ferrule to port 3 of the divert/inject valve. See Figure 4-2.
 - b. Connect the other end of the PEEK tubing with a (brown) fingertight fitting and a (brown) ferrule to the free end of the LC Tee union. (See Figure 4-1.)

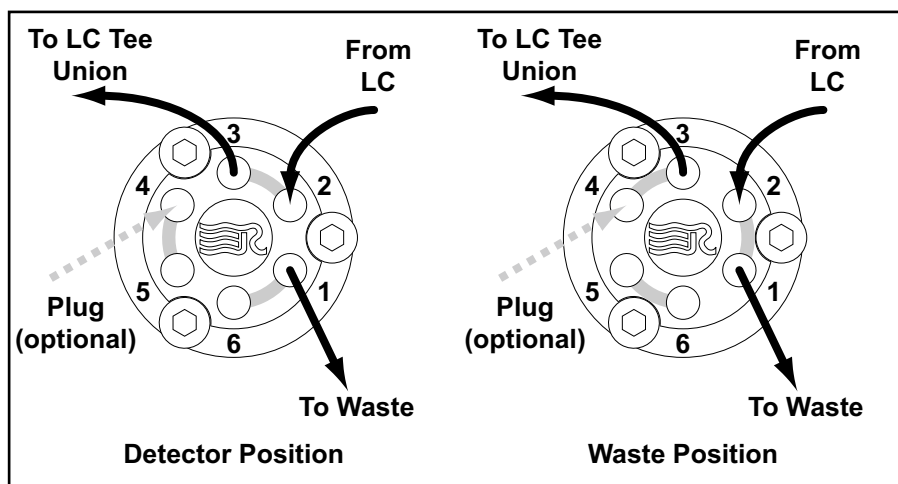

Figure 4-2. Divert/Inject valve, showing the correct setup for tuning by syringe infusion and showing the flow of liquid through the valve in the Detector and Waste positions

10. Connect an appropriate length of PEEK tubing (transfer line from the LC) from the divert/inject valve to the LC, as follows:
 - a. Connect a length of PEEK tubing with a (stainless steel) nut and a (stainless steel) ferrule to port 2 of the divert/inject valve.
 - b. Connect the other end of the PEEK tubing with a proper fitting and a ferrule to the outlet of the LC.
11. Connect an appropriate length of PEEK tubing (waste line) from the divert/inject valve to a waste container, as follows:
 - a. Connect a length of PEEK tubing with a (stainless steel) nut and a (stainless steel) ferrule to port 1 of the divert/inject valve.
 - b. Insert the other end of the PEEK tubing in a suitable waste container.

The MS detector is now properly set up to introduce your analyte by syringe pump into solvent flow from an LC.

Go to the next topic: **Setting Up to Tune the MS Detector with Your Analyte.**

4.2 Setting Up to Tune the MS Detector with Your Analyte

Use the following procedure to set up the MS detector to tune automatically on your analyte in ESI/MS mode. (In this example, you can use the reserpine solution described in **Appendix A: Sample Formulations**, or you can use a solution of your analyte of interest.)

Caution. Do not infuse calibration solution at flow rates above 10 $\mu\text{L}/\text{min}$. Ultramark 1621 can contaminate your system at high concentrations.

Note. The following procedures assume that you are familiar with your Finnigan LTQ instrument and the Tune Plus window. If you need additional guidance, refer to: Finnigan LTQ online Help and/or **Finnigan LTQ Hardware Manual**.

1. Open the Tune Plus window from the Start button on your Windows XP Desktop, as follows:



- a. Choose **Start > Programs > Xcalibur > Xcalibur** to display the Xcalibur Home Page – Roadmap view.
- b. Click on the Instrument Setup button to display the Instrument Setup window.
- c. Click on the Finnigan LTQ button to display the New Method page.
- d. Click on the Tune Plus button to display the Tune Plus window.



On



Standby

2. In Tune Plus, click on the On/Standby button to take the MS detector out of Standby mode and turn it On. The MS detector begins scanning, the Finnigan LTQ MS detector applies high voltage to the ESI probe, and the Finnigan LTQ MS detector shows a real-time display in the Spectrum view.

3. Open the *ESImyTune.LTQTune* Tune Method, the Tune Method you saved in Chapter 3, as follows:

- a. On the File/Display toolbar, click on the Open File icon to display the Open dialog box.
- b. Browse to the folder *C:\Xcalibur\methods*. Then, select the file *ESImyTune.LTQTune*.



- c. Click on **Open** to open the file. Tune Plus downloads the Tune Method parameters to the MS detector, and the title bar in the Tune Plus window should read as follows:

C:\Xcalibur\methods\ESI\myTune.LTQTune – Tune Plus

4. Define the scan parameters for tuning with your analyte in the ESI/MS mode, as follows:



- a. In the Instrument Control toolbar, click on the Define Scan button to open the Define Scan dialog box. See Figure 4-3.
- b. In the Scan Description group box, in the Mass Range list box, select *Normal* to allow for a selection of mass ranges between m/z 150 to 2000.
- c. In the Scan Rate list box, select *Normal* to specify a normal scan rate.
- d. In the Scan Type list box, select *SIM* specify a Selected Ion Monitoring experiment.
- e. In the Scan Time group box, in the Number of Microscans spin box, enter **1** to set the total number of microscans to 1.
- f. In the Max. Inject Time spin box, enter *200.000* to specify a 200 ms maximum injection time.
- g. In the Scan Ranges group box, in the Input list box, select *Center/Width* to make available the Center Mass and Width text boxes in the Scan Ranges table.
- h. In the Source Fragmentation group box, confirm that the On check box is not selected () to specify that the ion source fragmentation option is turned off.
- i. In the Scan Ranges group box, in the Scan Ranges table, in the Center Mass text box, enter **609.20** to set the center mass for the scan range to m/z 609.20 (for reserpine).
- j. In the Width text box, enter **2.0** to set the width of the scan range to 2.0 daltons.
- k. Ensure that the settings in your Define Scan dialog box are the same as those shown in Figure 4-3.
- l. Click on **OK** to apply the MS detector scan parameters and to close the Define Scan dialog box.

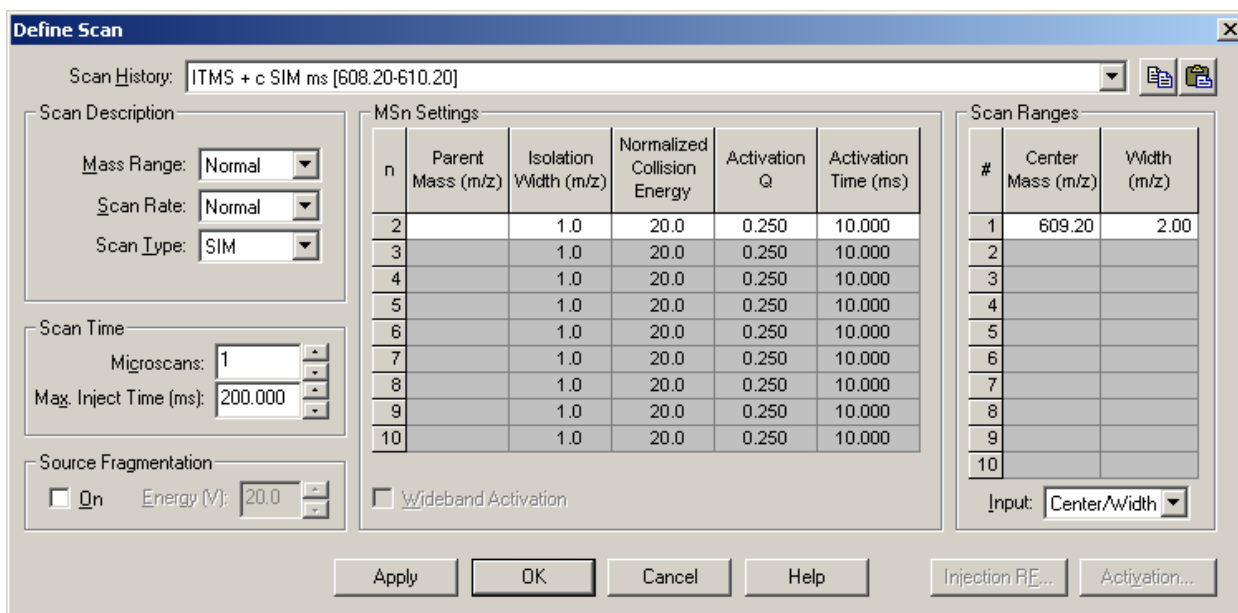

Figure 4-3. Define Scan dialog box, showing typical settings for acquiring reserpine data of the SIM type



5. On the Control/Scan Mode toolbar, click on the Centroid/Profile button to toggle the data type to profile. (The picture on the button should be the same as that shown here.)



6. Click on the Positive/Negative button to toggle the ion polarity mode to positive. (The picture on the button should be the same as that shown here).

You have completed setting up to tune your MS detector with your analyte in ESI/MS mode. Go to the next topic: **Optimizing the MS Detector Tune Automatically with Your Analyte.**

4.3 Optimizing the MS Detector Tune Automatically with Your Analyte

Optimize the MS detector tune automatically to maximize the ion transmission of reserpine (or your analyte of interest) for a high-flow experiment. It is recommended that you begin optimizing after you have successfully passed an automatic tuning procedure and an automatic calibration procedure with the calibration solution infused at 5 $\mu\text{L}/\text{min}$.

The following procedure describes how to optimize the MS detector Tune Method on the reserpine m/z 609.2 at an LC flow rate of 400 $\mu\text{L}/\text{min}$, but you can follow the same procedure with your analyte of interest and at your particular LC flow rate. (Refer to Table 1-2 for guidelines about setting flow rates and temperatures.)



1. On the Control/Scan Mode toolbar, click on the Tune button to display the Tune dialog box.
2. If necessary, click on the Automatic tab to display the Automatic tuning page. See Figure 4-4.
3. In the What to Optimize On group box, select the Mass option button to make active the Mass spin box.
4. In the Mass spin box, enter **609.2** (or the appropriate mass of your analyte of interest) to specify that the Finnigan LTQ MS detector use the peak at m/z 609.2 to optimize your tune.

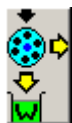

5. Ensure that the Divert/Inject valve is in the Detector position, as follows:
 - a. Click on the Divert/Inject button to open the Divert/Inject Valve dialog box. See Figure 4-5.
 - b. Select the Detector option button.
 - c. Click on **Close**.
6. Start the automatic tuning procedure from the Tune dialog box, as follows:
 - a. Click on **Start**. A message box displays the following message:
Please ensure that the 500 microliter syringe is full.
Ensure the syringe pump contains at least 450 μL of the 125 $\text{fg}/\mu\text{L}$ reserpine tuning solution.
 - b. Click on **OK** to close the message box, and return to the Tune Plus window.



7. In the File/Display toolbar, click on the Graph View button to display the Graph view.

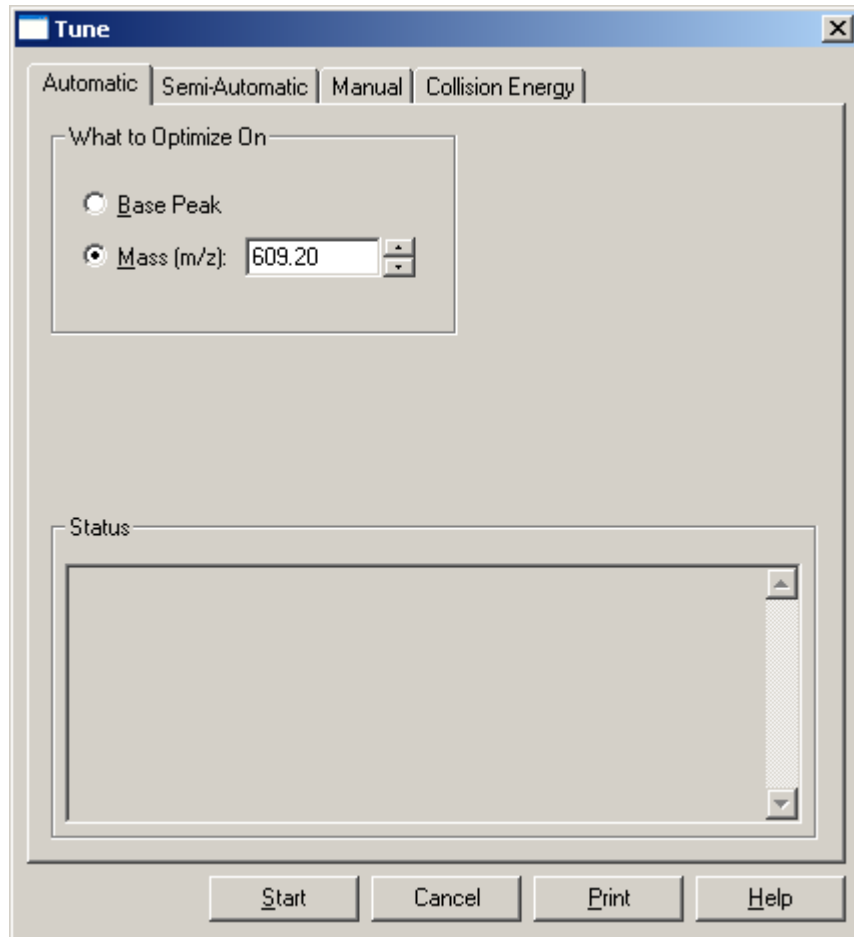

Figure 4-4. Tune dialog box, showing the Automatic tuning page

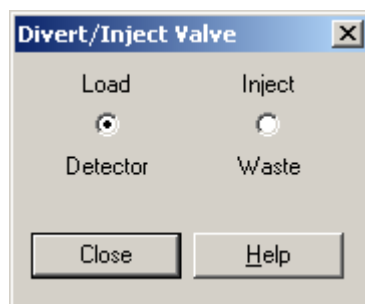

Figure 4-5. Divert/Inject Valve dialog box

8. Observe the Tune Plus window and the Tune dialog box. While automatic tuning is in progress, the Finnigan LTQ MS detector displays various tests in the Spectrum and Graph views in the Tune Plus window and displays various messages in the Status group box in the Tune dialog box.

Your Tune Plus window should now look similar to the one shown in Figure 4-6.

Note. The most important parameters that affect the signal quality during ESI/MS operation are the electrospray voltage, ion transfer capillary temperature, heated capillary voltage, tube lens voltage, gases, and solution flow rate. If any one of these parameters is changed, you need to reoptimize MS detector parameters. You can use the Semi-Automatic tune procedure to tune the MS detector on individual parameters.

You have now successfully tuned the MS detector in ESI/MS mode for the compound reserpine (or your analyte of interest). Go to the next topic: **Saving the ESI/MS Tune Method.**

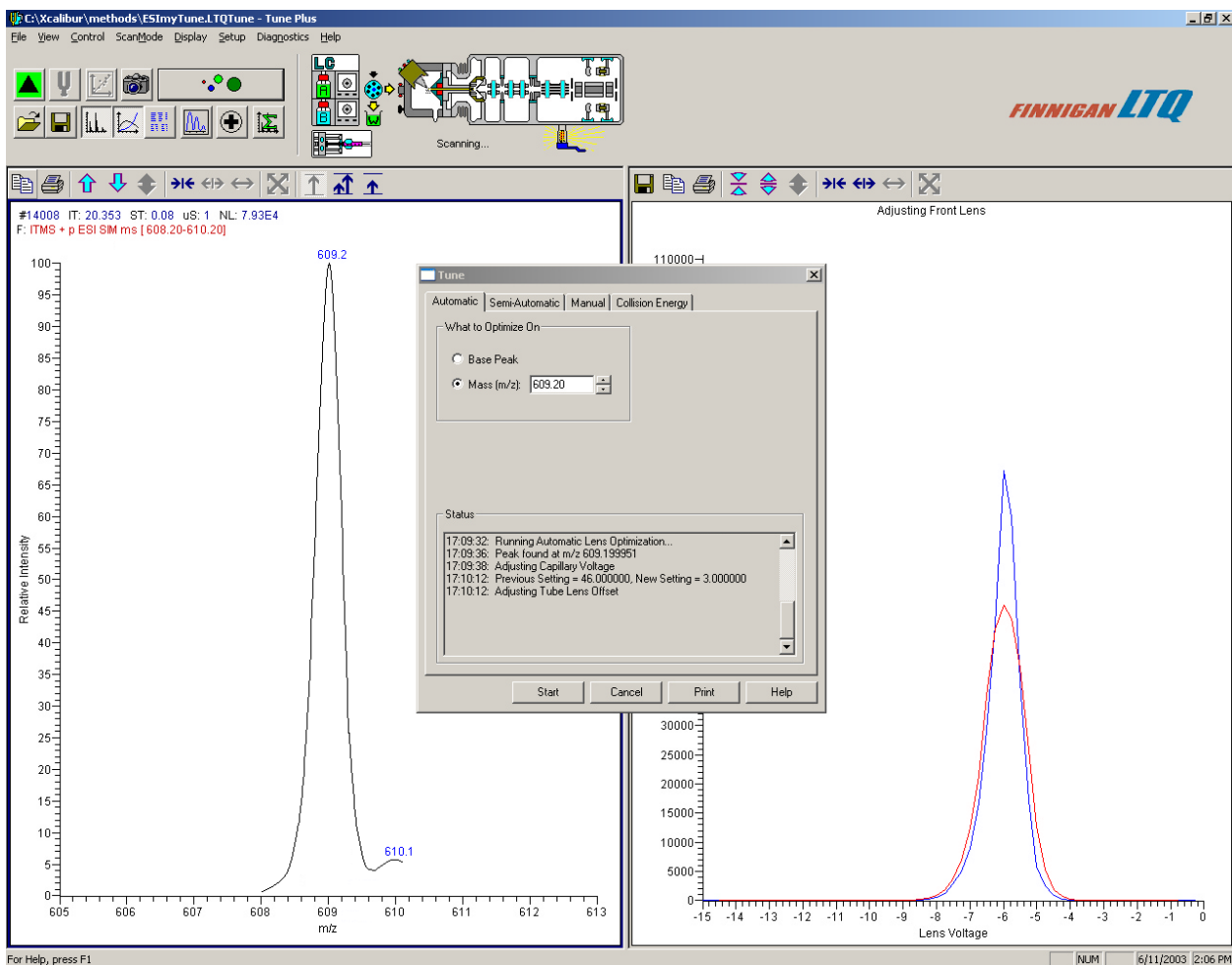

Figure 4-6. Tune Plus window with the Tune dialog box, showing the Automatic tuning page

4.4 Saving the ESI/MS Tune Method

Save your ESI/MS Tune Method (for a high-flow experiment using your analyte) when automatic tuning is complete, as follows:

Note. Save the Tune Method while the MS detector is On, if any of the ion source parameters are different from those with which you started.

1. Choose **File > Save As** to display the Save As dialog box. See Figure 4-7.

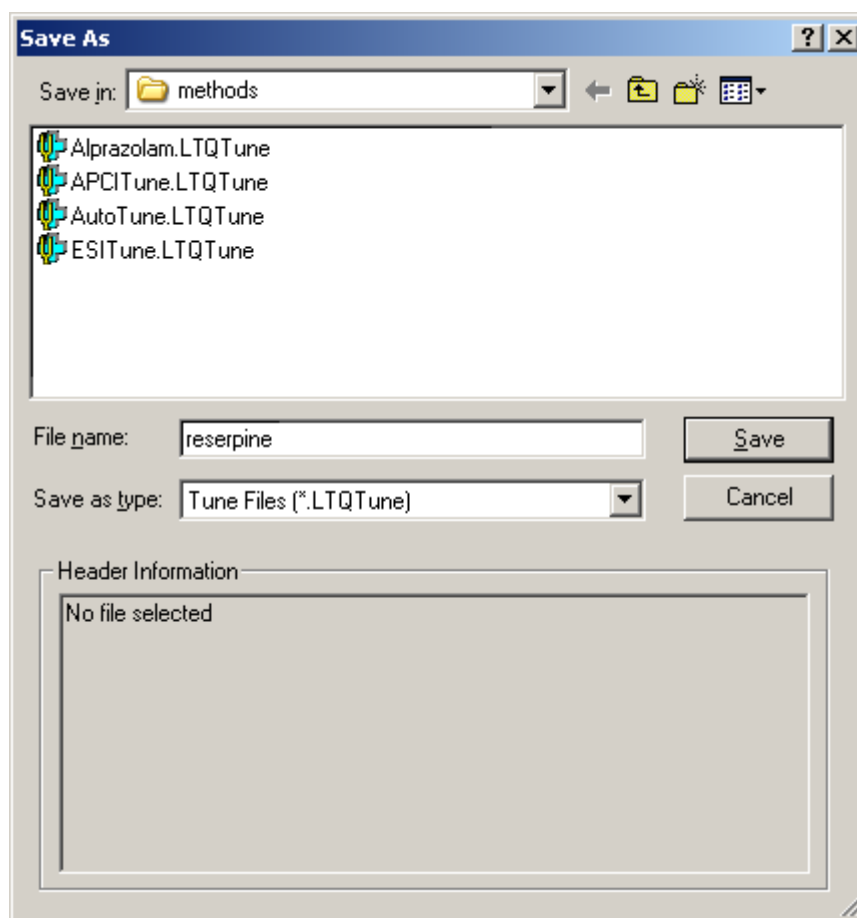

Figure 4-7. Save As dialog box, showing files in the folder C:\Xcalibur\methods

2. Select the *C:\Xcalibur\methods* folder.
3. Click on the File Name text box, and enter **reserpine** (or the name of your analyte of interest).
4. Click on **Save** to save the Tune Method, and return to the Tune Plus window. Note that the Tune Method is named *reserpine.LTQTune*.

The Tune Method is now properly saved and you are ready to acquire data on your analyte of interest.

Go to the next chapter: **Acquiring ESI Sample Data Using the Tune Plus Window.**

Chapter 5

Acquiring ESI Sample Data Using the Tune Plus Window

This chapter describes how to acquire LC/ESI/MS sample data using the Tune Plus window. This experiment uses reserpine but you can follow the same procedure with your analyte of interest.

Note. The following procedures assume that you are familiar with your Finnigan LTQ instrument and the Tune Plus window. If you need information, refer to the Finnigan LTQ online Help, **Finnigan LTQ Getting Connected**, and/or **Finnigan LTQ Hardware Manual**.

Ensure that you have completed the procedures in the topics **Tuning and Calibrating Automatically in the ESI/MS Mode** and **Tuning with Your Analyte in LC/ESI/MS Mode**.

This chapter contains the following topics:

- Setting Up to Acquire MS/MS Data in the Full Scan Type
- Setting Up to Introduce Sample by Loop Injection into Solvent Flow from an LC
- Acquiring MS Data in the SIM Scan Type

5.1 Setting Up to Acquire MS/MS Data in the Full Scan Type

Prepare to acquire MS/MS data in the Full scan type on reserpine (or on your analyte of interest). You need to optimize the isolation width and the relative collision energy parameters before you acquire MS/MS data.

You first optimize the isolation width to ensure that the ion of interest is isolated effectively, and then you optimize the collision energy to ensure that fragmentation of the parent ion is efficient. The relative collision energy for a particular analysis depends on the type of sample you are analyzing.

The information in this topic applies to operation of the Finnigan LTQ MS detector in either the ESI or the APCI mode.

This topic contains the following subtopics:

- Optimizing the Isolation Width and Setting Up to Optimize the Collision Energy
- Optimizing the Collision Energy Automatically for an MS/MS Experiment

Optimizing the Isolation Width and Setting Up to Optimize the Collision Energy

Optimize the isolation width and set up to optimize the collision energy for an MS/MS experiment, as follows:

Note. The collision energy is optimized on the Finnigan LTQ MS detector by changing the values for the parameter *Normalized Collision Energy* in the MSⁿ Settings group box of the Define Scan dialog box. *For this experiment, and for most applications, leave the parameters Activation Q and Activation Time set to their default values.* For more information about these parameters, refer to the online Help.



On



Standby



1. If you have not already done so, from the Tune Plus window, click on the On/Standby button to take the MS detector out of Standby mode and turn it On.
2. Ensure that the Centroid data type is selected. (The picture on the button should be the same as that shown here.)
3. Ensure that the scan parameters are defined to acquire MS/MS Full scan data for reserpine (or your analyte of interest), as follows:
 - a. Click on the Define Scan button to open the Define Scan dialog box. See Figure 5-1.

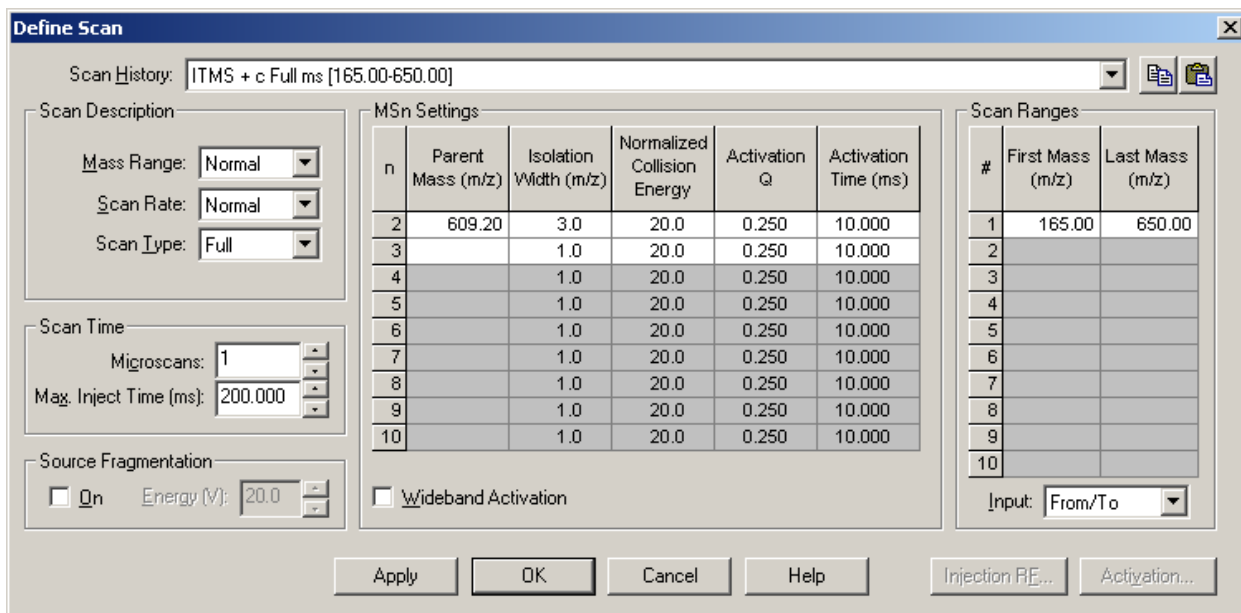

Figure 5-1. Define Scan dialog box, showing initial settings to optimize the isolation width of an MS/MS experiment for reserpine

- b. Ensure that the values in your dialog box are the same as those shown in Figure 5-1. Start with a relatively wide Isolation Width. Leave the Define Scan dialog box open.
4. At this time you might want to turn on your LC pump and specify a flow rate of 0.4 mL/min, for example, to ensure that your system does not leak.
5. Click on the Syringe Pump button to display the Syringe Pump dialog box. See Figure 5-2.
6. Turn on the syringe pump and set an infusion flow rate of 5 µL/min, as follows:
 - a. In the Flow Control group box, click on the On option button to make active the Flow Rate spin box.
 - b. Enter 5 in the Flow Rate spin box to specify a rate of 5 µL/min.



Note. This procedure assumes that you are using the 500-µL Unimetrics syringe that is provided with your Finnigan LTQ system. If you are using another type of syringe, select the option button corresponding to your syringe.

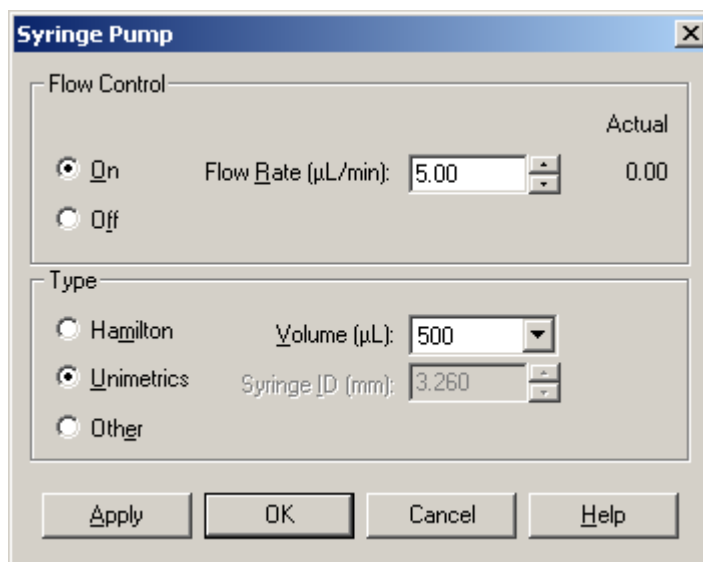

Figure 5-2. Syringe Pump dialog box

- c. If you are using a standard Unimetrics (or Hamilton) syringe, set up the syringe parameters as follows:
 - i. In the Type group box, click on the Unimetrics (or Hamilton) option button to specify the proper syringe type.
 - ii. Click on the Volume list box arrow to display the list of available volumes, and then select 500 (or your syringe size) from the list to set the proper syringe volume. Note that, if you are using a Unimetrics syringe, the Finnigan LTQ MS detector automatically sets the syringe ID to its proper value of 3.260 mm.
- d. If you are not using a Unimetrics (or Hamilton) syringe, set up the syringe parameters as follows:
 - i. In the Type group box, click on the Other option button to make active the syringe ID spin box.
 - ii. Enter the inner diameter of your syringe in the Syringe ID spin box.
- e. Click on **Apply** to apply the syringe parameters and start the syringe pump.
- f. Finally, move the Syringe Pump dialog box out of the way, to the top of the monitor screen.

7. In the Tune Plus window, observe the mass spectrum of reserpine (or your analyte of interest). Also observe the values for *NL* and *IT* (*Normalization Level* and *Ion Time*), while you optimize the value of the Isolation Width in the Define Scan dialog box, as follows:
 - a. In the Define Scan dialog box, in the MSⁿ Settings group box, in the Isolation Width spin box, enter **3** to specify an isolation width of *m/z* 3. Then, click on **Apply**.
 - b. In the Tune Plus window, observe the mass spectrum for the parent ion of reserpine, *m/z* 609.2. Ensure that the readback values for *NL* and *IT* are relatively stable.
 - c. Again, in the Define Scan dialog box, in the MSⁿ Settings group box, in the Isolation Width spin box, enter **2.8** to specify an isolation width of *m/z* 2.8. Then, click on **Apply**.

Note. The optimum value for Isolation Width is one that is the smallest (to a minimum width of *m/z* 0.4), but which results in a mass spectrum of maximum intensity for only the ions of interest. The Isolation Width is optimized when the values for *NL* and *IT* are stable and when the mass peak for the parent ion is of maximum intensity and appears symmetrical.

If you specify a value for Isolation Width that is less than the optimum value, the readback for *NL* drops substantially. A significant drop in sensitivity indicates that your ions of interest are not effectively isolated.

- d. Repeat steps b and c above, entering successively smaller values for Isolation Width. Continue to observe the intensity of the mass spectrum of the parent ion, and ensure that the values for *NL* and *IT* are stable with each change you make to the Isolation Width.

Note. After the Isolation Width is optimized, you might compensate for minor changes in tune stability by increasing the value by up to *m/z* 1.

8. In the Define Scan dialog box, in the MSⁿ Settings group box, in the Normalized Collision Energy spin box, enter **20** to specify an initial value of 20 for the collision energy. Then, click on **Apply**.
9. In the Tune Plus window, observe the mass spectrum of the product ions of reserpine (or your analyte of interest). If necessary, increase the value for the Normalized Collision Energy in increments of 5% to cause the clear display of product ion mass spectrum. (After each change in value, click on **Apply** to implement the change.) See Figure 5-3.
10. When you have clearly identified a product ion mass-to-charge ratio for reserpine (or your analyte of interest), click on the Tune button to display the Tune dialog box.
11. In the Tune dialog box, click on the Collision Energy tab to display the page. See Figure 5-4.



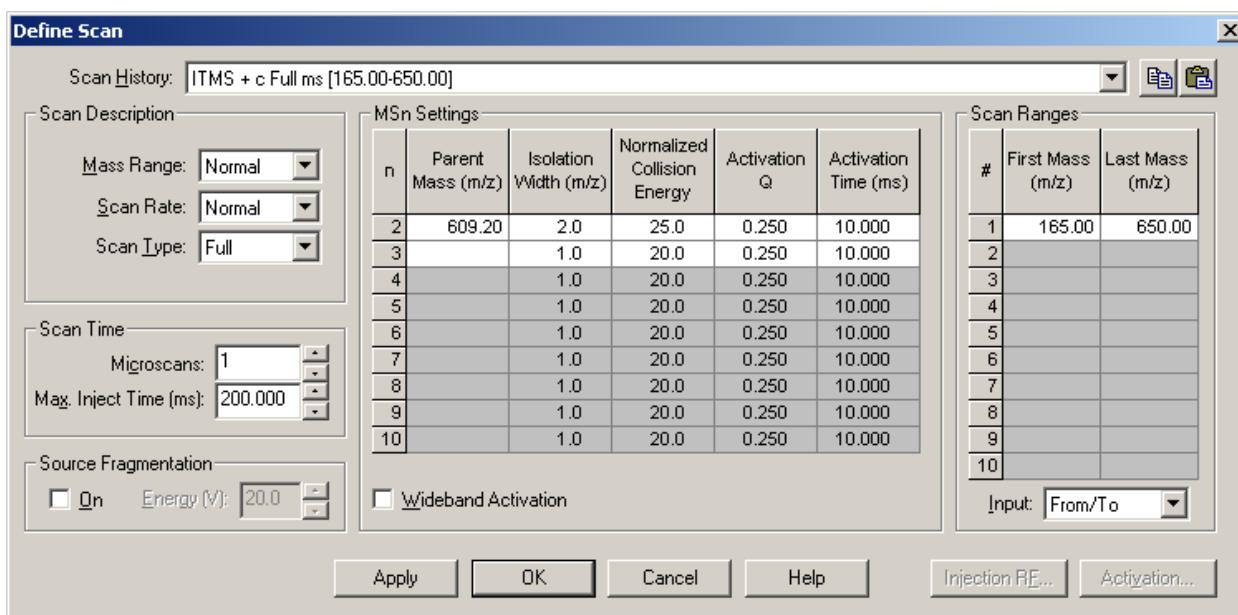

Figure 5-3. Define Scan dialog box, showing typical settings for acquiring MS/MS data in the Full scan type on reserpine

- Click on the Product Ion Mass option button to make active the spin box. Then, enter **397.2** to specify the product ion at m/z 397.2 for reserpine. The Finnigan LTQ MS detector can optimize collision energy automatically by using this product ion of reserpine.

Go to the next topic: **Optimizing the Collision Energy Automatically for an MS/MS Experiment.**

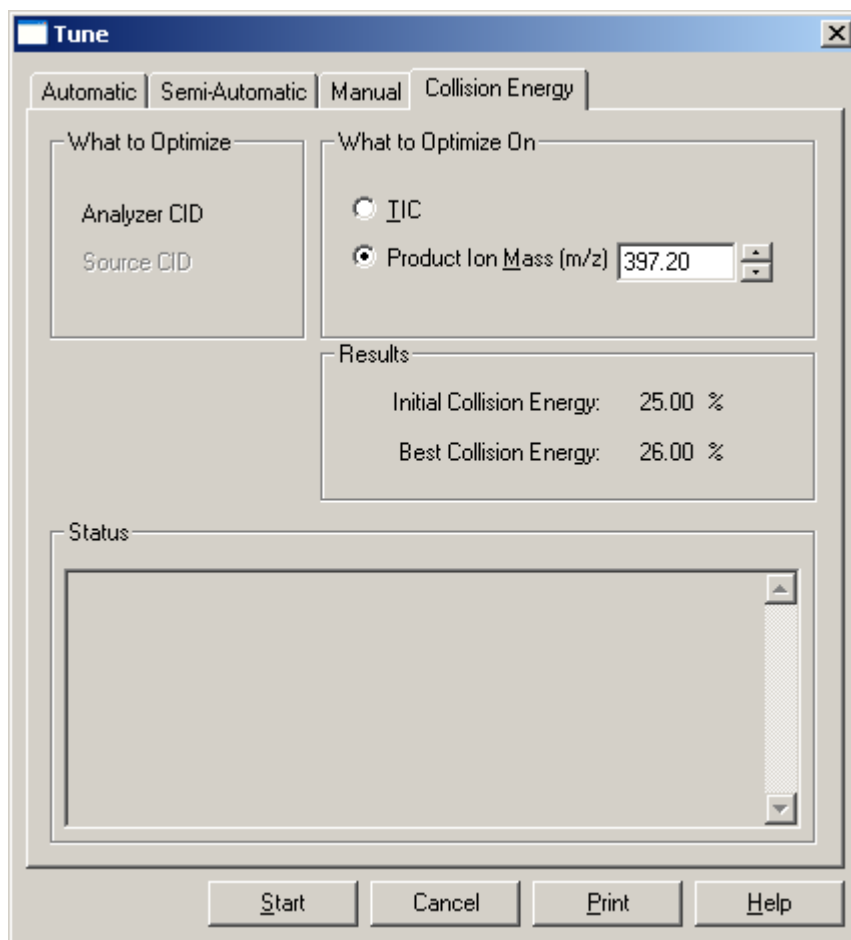

Figure 5-4. Tune dialog box, showing the Collision Energy page

Optimizing the Collision Energy Automatically for an MS/MS Experiment

The optimum relative collision energy is the one that produces the maximum product ion intensity. Optimize the relative collision energy automatically for the ESI/MS/MS analysis of reserpine (or your analyte of interest), as follows:

1. In the Tune dialog box, on the Collision Energy page (Figure 5-4), click on **Start** to start the optimization procedure. A message box displays the following message:

Please ensure that the 500 microliter syringe is full.

Ensure the syringe contains at least 450 μL of the 125 $\text{fg}/\mu\text{L}$ reserpine solution.

2. Click on **OK** to close the message box, and leave the Tune dialog box open. Your Tune Plus window should now look similar to the one shown in Figure 5-5.
3. In the Spectrum view of Tune Plus, observe the MS/MS Full scan spectrum of reserpine (or that of your analyte of interest).
4. When the collision energy is optimized, the Accept Optimized Value dialog box appears. See Figure 5-6.
5. Click on the Accept button to accept the new collision energy value, and return to Tune Plus. The new value is displayed in the Define Scan dialog box.
6. In the Syringe Pump dialog box, select the Off option button to turn off the syringe pump. Then, click on **Close** to close the Syringe Pump dialog box.
7. Click on **Cancel** to close the Tune dialog box.

After you optimize the relative collision energy, the Finnigan LTQ MS detector is ready to acquire MS/MS data on your analyte of interest.

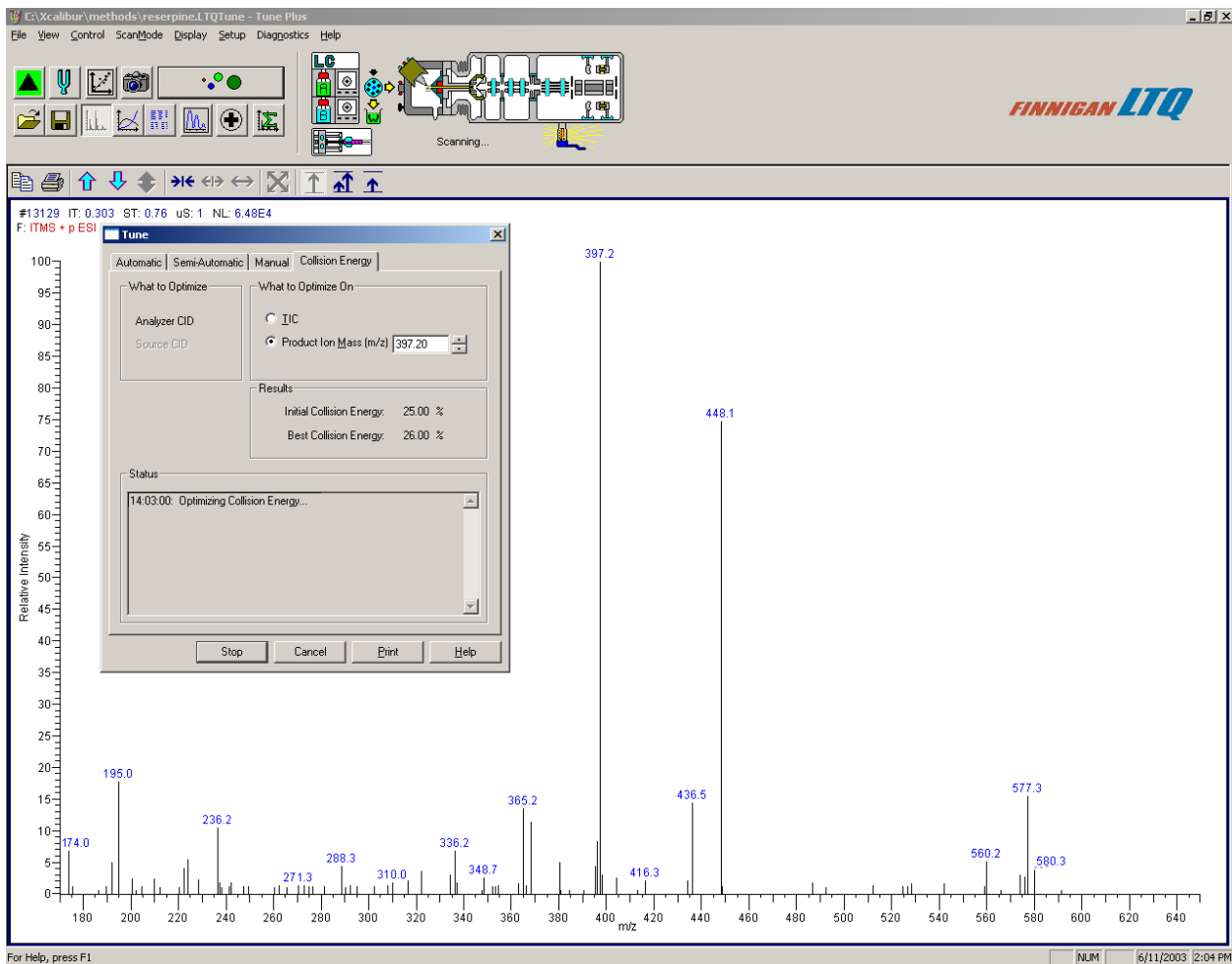

Figure 5-5. Tune Plus window, showing MS/MS product ions of reserpine in the Spectrum view

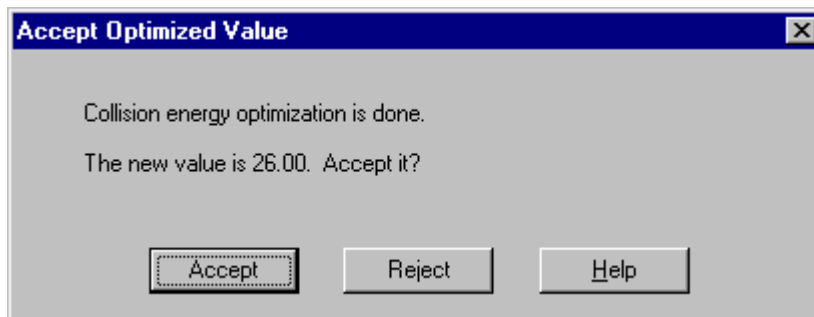

Figure 5-6. Accept Optimized Value dialog box

5.2 Setting Up to Introduce Sample by Loop Injection into Solvent Flow from an LC

Set up to introduce sample by loop injection into solvent flow from an LC.

To make the plumbing connections for ESI/MS sample introduction by loop injection into solvent flow from an LC, do the following:

1. If you have not already done so, connect the PEEK safety sleeve and fused-silica sample tube from the grounding union to the ESI probe sample inlet as described in the topic: **Installing a New Fused-Silica Sample Tube and PEEK Safety Sleeve in Finnigan Ion Max API Source Hardware Manual**.

If you have installed the stainless steel needle in the ESI probe, connect the PEEK safety sleeve and fused-silica capillary tube from the grounding union to the ESI probe sample inlet as described in the topic: **Installing a New Stainless Steel Needle in the ESI Probe and Installing a New Fused-Silica Sample Tube and PEEK Safety Sleeve in Finnigan Ion Max API Source Hardware Manual**.

2. Connect an appropriate length of (red) PEEK tubing (transfer line from the divert/inject valve) from the divert/inject valve to the (stainless steel) grounding union, as follows. See Figure 5-7.
 - a. Connect a length of PEEK tubing fitted with a (stainless steel) nut and a (stainless steel) ferrule to port 3 of the divert/inject valve. See Figure 5-8.
 - b. Connect the other end of the PEEK tubing with a (brown) fingertight fitting and a (brown) ferrule to the free end of the grounding union.
3. Connect a 5 μ L sample loop with (stainless steel) nuts and (stainless steel) ferrules to ports 1 and 4 of the divert/inject valve. (See Figure 5-8)

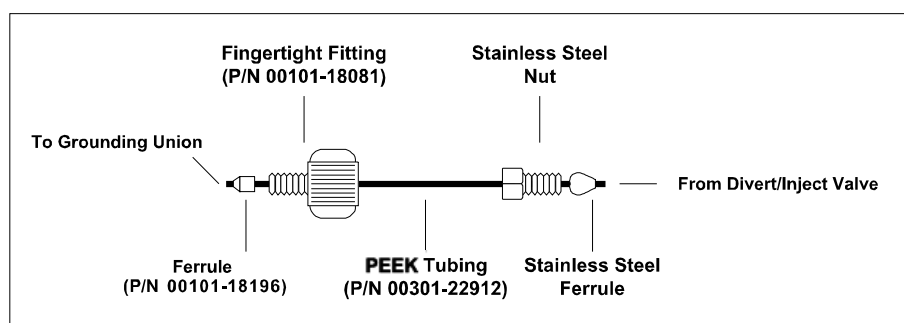

Figure 5-7. ESI/MS plumbing connections for the divert/inject valve and grounding union

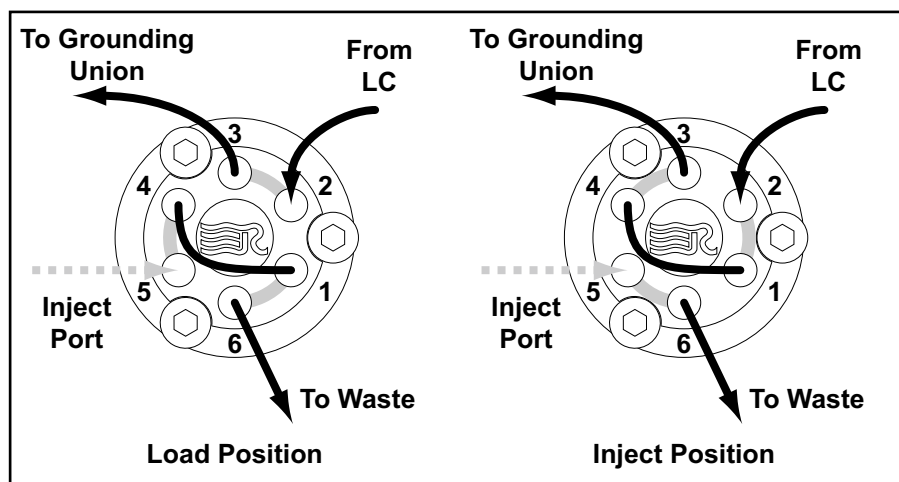

Figure 5-8. Divert/Inject valve, showing the correct setup for analysis by loop injection and showing the flow of liquid through the valve in the Load and Inject positions

4. Connect an appropriate length of PEEK tubing (transfer line from the LC) from the divert/inject valve to the LC, as follows:
 - a. Connect a length of the PEEK tubing with a (stainless steel) nut and (stainless steel) ferrule to port 2 of the divert/inject valve.
 - b. Connect the other end of the PEEK tubing with a proper fitting and a ferrule to the outlet of the LC.
5. Connect an appropriate length of PEEK tubing (waste line) from the divert/inject valve to a waste container, as follows:
 - a. Connect a length of PEEK tubing with a (stainless steel) nut and (stainless steel) ferrule to port 6 of the divert/inject valve.
 - b. Insert the other end of the PEEK tubing into a suitable waste container.

5.3 Acquiring MS Data in the SIM Scan Type

Use the following procedure to acquire a file of reserpine data in the selected ion monitoring (SIM) type from the Tune Plus window. The Finnigan LTQ MS detector automatically saves the data you acquire on your hard disk.



On



Standby



1. On the Control/Scan Mode toolbar, click on the On/Standby button to take the MS detector out of Standby mode and turn it On. The MS detector begins scanning, the Finnigan LTQ MS detector applies high voltage to the ESI probe, and a real-time display shows in the Spectrum view.
2. Ensure that the Centroid data type is selected. (The picture on the button should be the same as that shown here.)
3. Ensure that the scan parameters are defined to acquire SIM data for reserpine (or your analyte of interest), as follows:
 - a. Click on the Define Scan button to open the Define Scan dialog box. See Figure 5-9.
 - b. Compare the values in your dialog box to those in Figure 5-9. Then, click on **OK**.

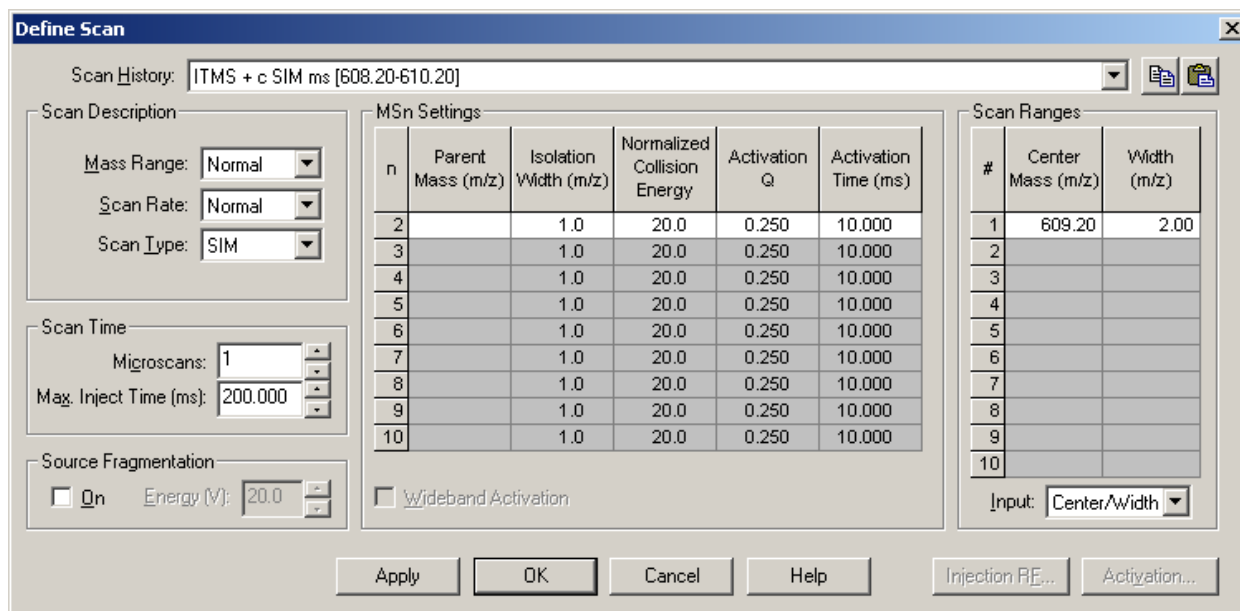

Figure 5-9. Define Scan dialog box, showing typical settings for acquiring reserpine data in the SIM scan type



4. Turn on the LC pump and specify your flow rate of 400 µL/min. Ensure that your system is free of leaks.
5. On the Control/Scan Mode toolbar, click on the Acquire Data button to open the Acquire Data dialog box. See Figure 5-10.
6. Specify the acquisition parameters, as follows:
 - a. In the File Name text box, enter **reserpine** to specify a filename.
 - b. In the Sample Name text box, enter **reserpine** to specify the sample identity. If you are not using reserpine, type the name of your particular analyte.
 - c. Enter a comment about your experiment. (For example, describe the scan mode, scan type, ionization mode, sample amount, or method of sample introduction.). The Xcalibur data system includes the comment on hard copies of your data.
 - d. In the Acquire Time group box, select the Continuously option button to acquire data continuously (until you stop the acquisition).
7. Leave the Acquire Data dialog box open during data acquisition, but move it to a corner of the Tune Plus window.
8. Click on **Start** in the Acquire Data dialog box to begin acquiring data. The Acquisition Status group box displays the following message.

State: Acquiring

Time (min):



9. Click on the Divert/Inject Valve button to open the Divert/Inject Valve dialog box. See Figure 5-11.

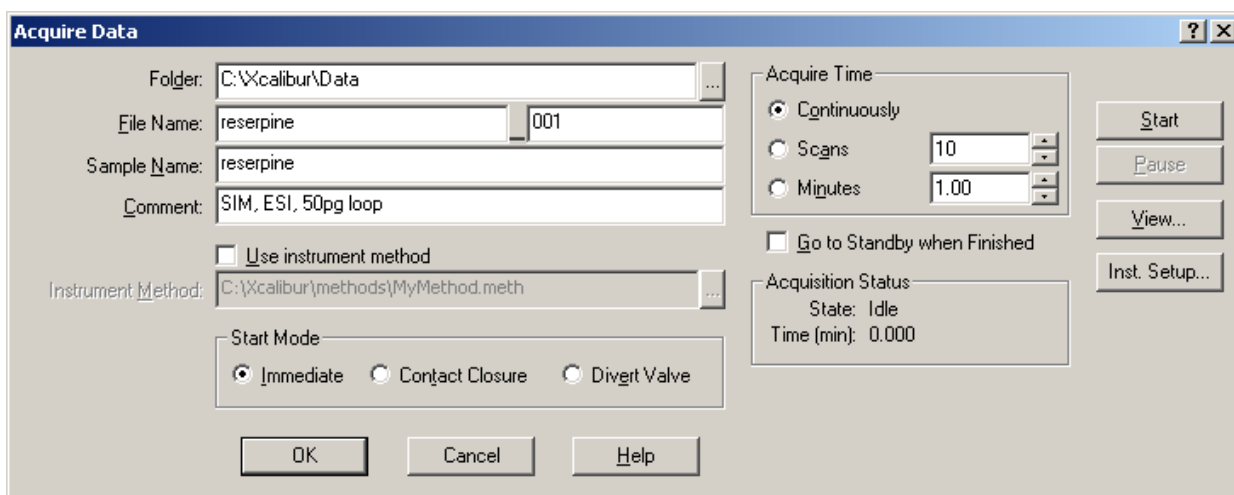

Figure 5-10. Acquire Data dialog box, showing typical settings for acquiring data

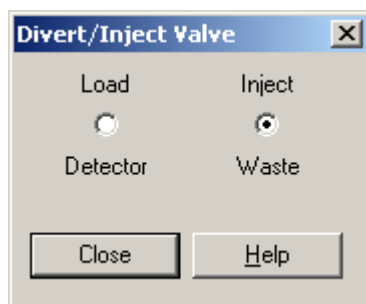

Figure 5-11. Divert/Inject Valve dialog box

10. Select the Load option button, and overfill the 5- μ L injector loop with the 125 fg/ μ L solution of reserpine (or a solution of your analyte of interest).
11. Select the Inject option button to inject the reserpine solution into the ESI source. Leave the Divert/Inject Valve dialog box open.
12. Observe the reserpine peak (m/z 609.2), or that of your analyte of interest, in the Spectrum view. See Figure 5-12. Wait about 1 min before you inject again (step 13.b, below).
13. Perform the following repetitive sequence to obtain a total of four consecutive loop injections of reserpine.
 - a. Select the Load option button, and overfill the injector loop with the 125 fg/ μ L solution of reserpine.
 - b. Select the Inject option button to inject the reserpine solution into the ESI source, and then observe the Spectrum view.
 - c. Wait 1 min before performing the next injection.
 - d. Perform step 13.a through step 13.c three more times.
14. Click on **Close** in the Divert/Inject Valve dialog box to return to the Tune Plus window.
15. Click on **Stop** in the Acquire Data dialog box to end the data acquisition. Then, click on **Cancel** to close the Acquire Data dialog box.

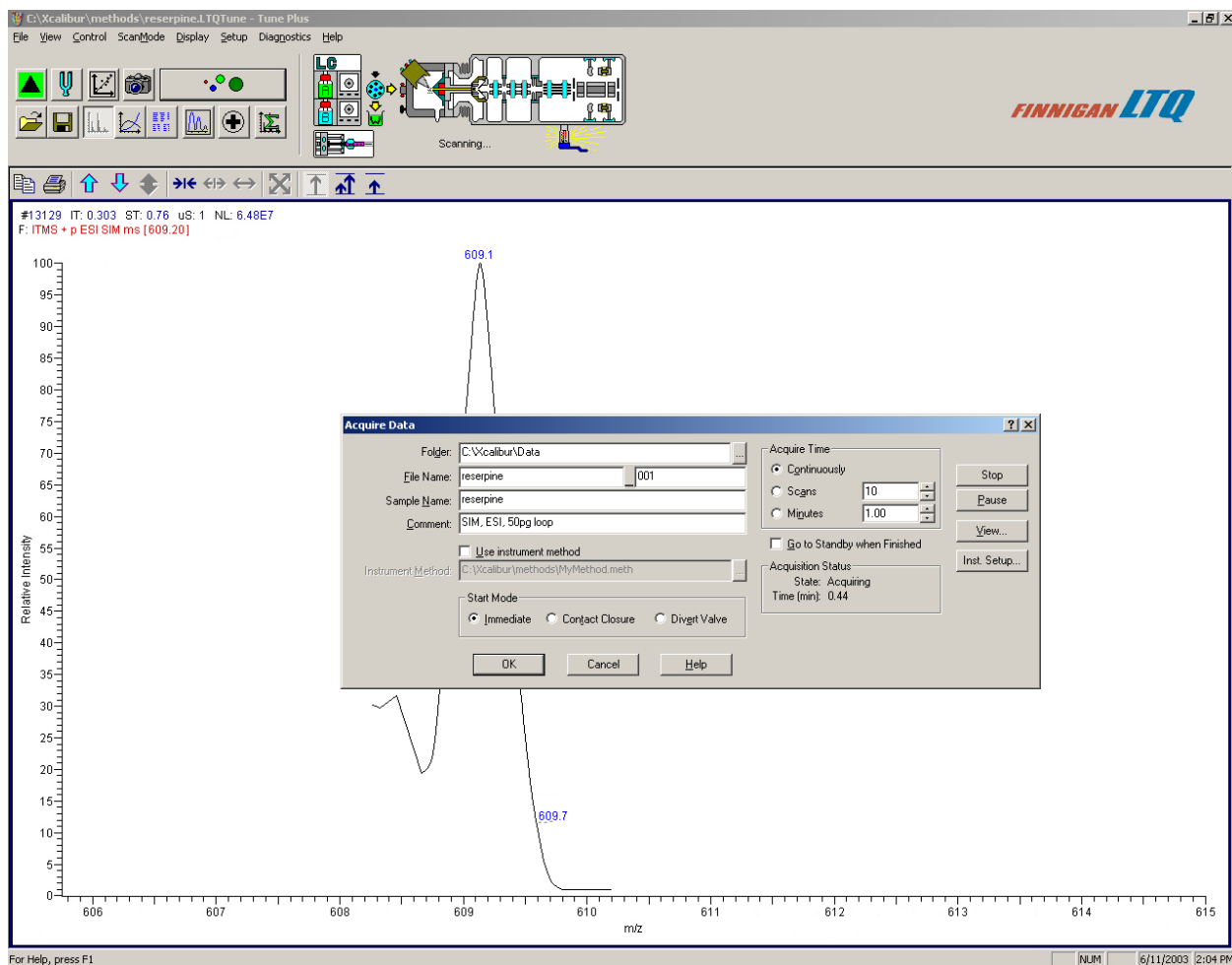

Figure 5-12. Tune Plus window, showing the SIM spectrum of reserpine during analysis by loop injection

Review the mass spectrum and chromatogram in the Xcalibur Qual Browser window. See Figure 5-13.

For more information about reviewing the data you acquired using the Finnigan LTQ MS detector with the Xcalibur data system, refer to the manual: **Xcalibur Getting Productive: Qualitative Analysis.**

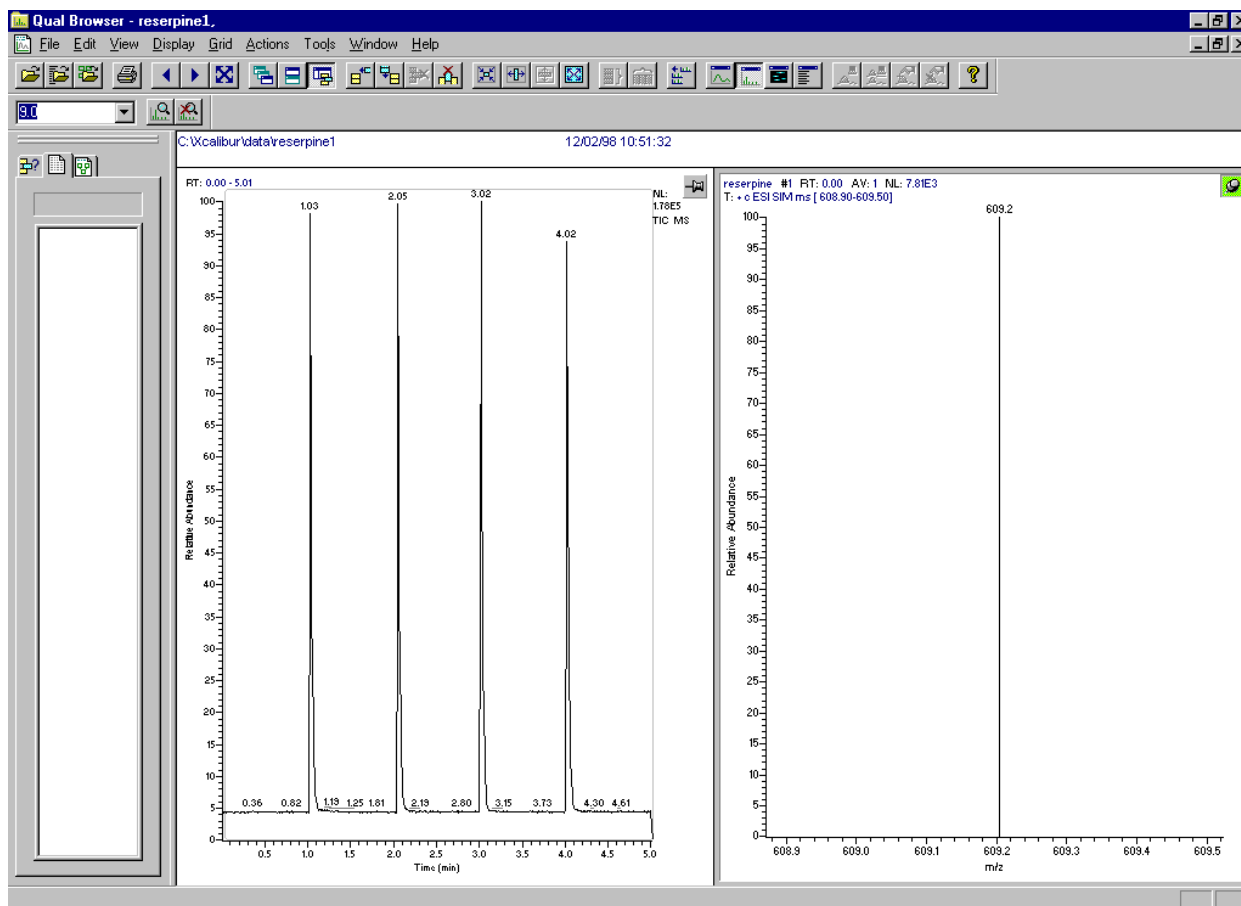

Figure 5-13. Qual Browser window, showing loop injections of reserpine in the Chromatogram view (left) and showing m/z 609 in the Spectrum view. Note that the injections occur at intervals of approximately 1 min

Chapter 6

Setting Up the Ion Source for Acquiring Data in APCI/MS/MS Mode

This chapter provides information on setting up the ion source for acquiring data in the APCI/MS/MS mode.

This chapter contains the following topics:

- Removing the ESI Probe
- Removing the Ion Max Ion Source Housing
- Removing the Ion Sweep Cone (optional)
- Installing the Corona Needle
- Installing the Ion Max Ion Source Housing
- Installing the APCI Probe

6.1 Removing the ESI Probe

Remove the ESI probe from the Ion Max ion source housing as follows:



On



Standby

1. Place the LC/MS system in Standby:
 - a. Stop the flow of solvent to the ESI source:
 - i. On the Control / Scan Mode toolbar, click on the Inlet Direct Control button to display the Inlet Direct Control dialog box.
 - ii. In the Direct Control Panel group box, click on the Pump Off button to stop the flow of solvent.
 - b. Click on the On/Standby button on the Control / Scan Mode toolbar to place the MS detector in Standby.
2. Disconnect the sample transfer tubing from the stainless steel ZDV fitting (grounding union). See Figure 6-1.
3. Remove the 8 kV cable from the ESI needle high voltage receptacle as follows: (See Figure 6-1.)
 - a. Unlock the cable by rotating the locking ring counter-clockwise.
 - b. Unplug the 8 kV cable from the ESI needle high voltage receptacle.

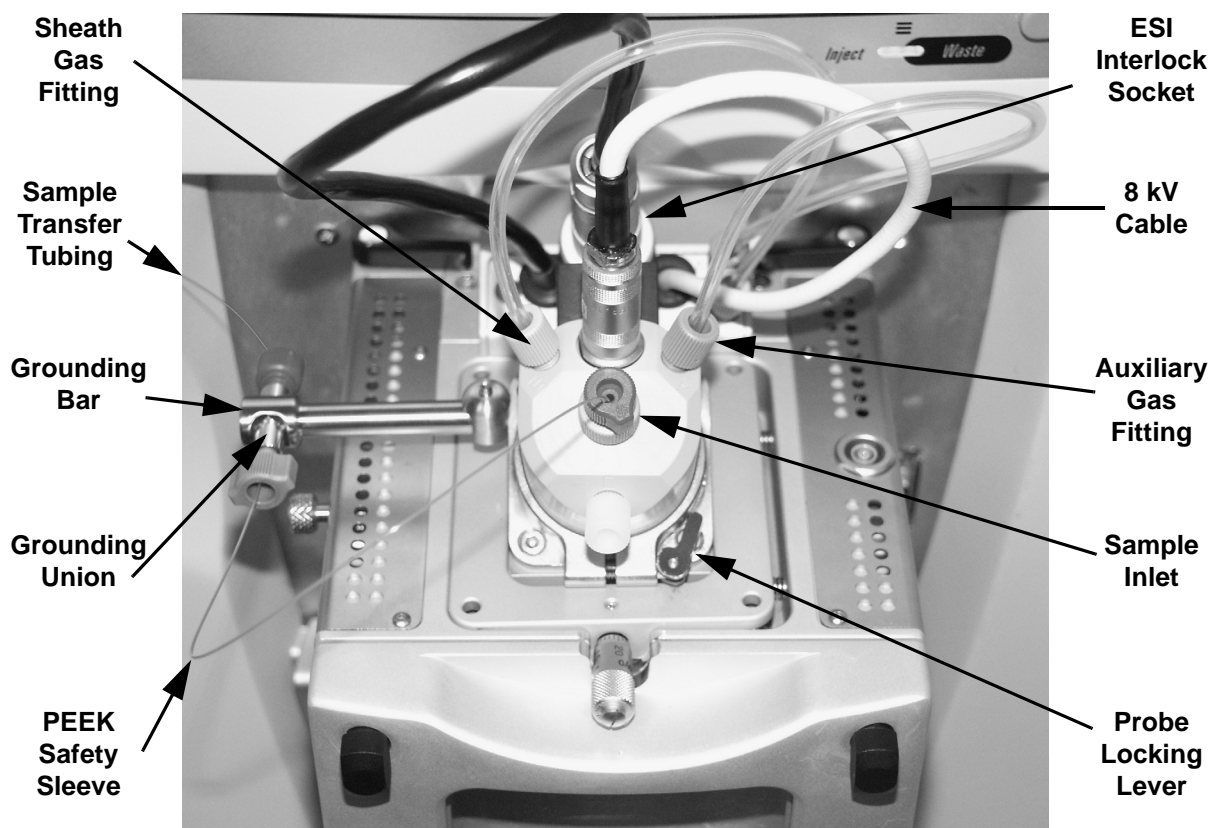

Figure 6-1. Ion Max ion source housing with ESI probe installed

4. Disconnect the Auxiliary Gas fitting (green) from the auxiliary gas inlet (A) on the probe manifold. (Figure 6-1.)
5. Disconnect the Sheath Gas fitting (blue) from the sheath gas inlet (S) on the probe manifold.
6. Remove the stainless steel ZDV fitting (Grounding Union) from the grounding bar on the ion source housing.
7. Unlock the probe locking lever by rotating the lever open to its widest position.
8. Carefully pull the probe straight back in the port in the housing until it meets with the slot in the API interlock block. The guide pin on the probe manifold will prevent you from rotating the probe until the pin is aligned with the slot in the API interlock block. Once the probe is all the way back and aligned with the slot, turn the probe 45 degrees counter-clockwise to free the probe from the alignment notch. Be careful not to break the fused-silica sample tube or PEEK safety sleeve.
9. Pull the probe straight out to remove it from the ion source housing.
10. Store the ESI probe in its original shipping container.

The ESI probe is properly removed from the Ion Max ion source housing.

Go to the next topic: **Removing the Ion Max Ion Source Housing.**

6.2 Removing the Ion Max Ion Source Housing

You need to remove the ion source housing to access the ion sweep cone.

Note. Disconnect any external liquid lines connected to the ion source housing before removing the ion source housing.

Remove the Ion Max ion source housing as follows:

1. Remove the drain tube from the ion source housing drain. See Figure 6-2.
2. Rotate the ion source housing locking levers 90 degrees to release the ion source housing from the ion source mount assembly.
3. Remove the ion source housing by pulling the housing straight off of the ion source mount assembly.
4. Place the housing in a safe location for temporary storage.

The Ion Max ion source housing is now properly removed. If you want to remove the ion sweep cone, go to the next topic: **Removing the Ion Sweep Cone**; otherwise, go to the topic **Installing the Corona Needle** on page 6-6.

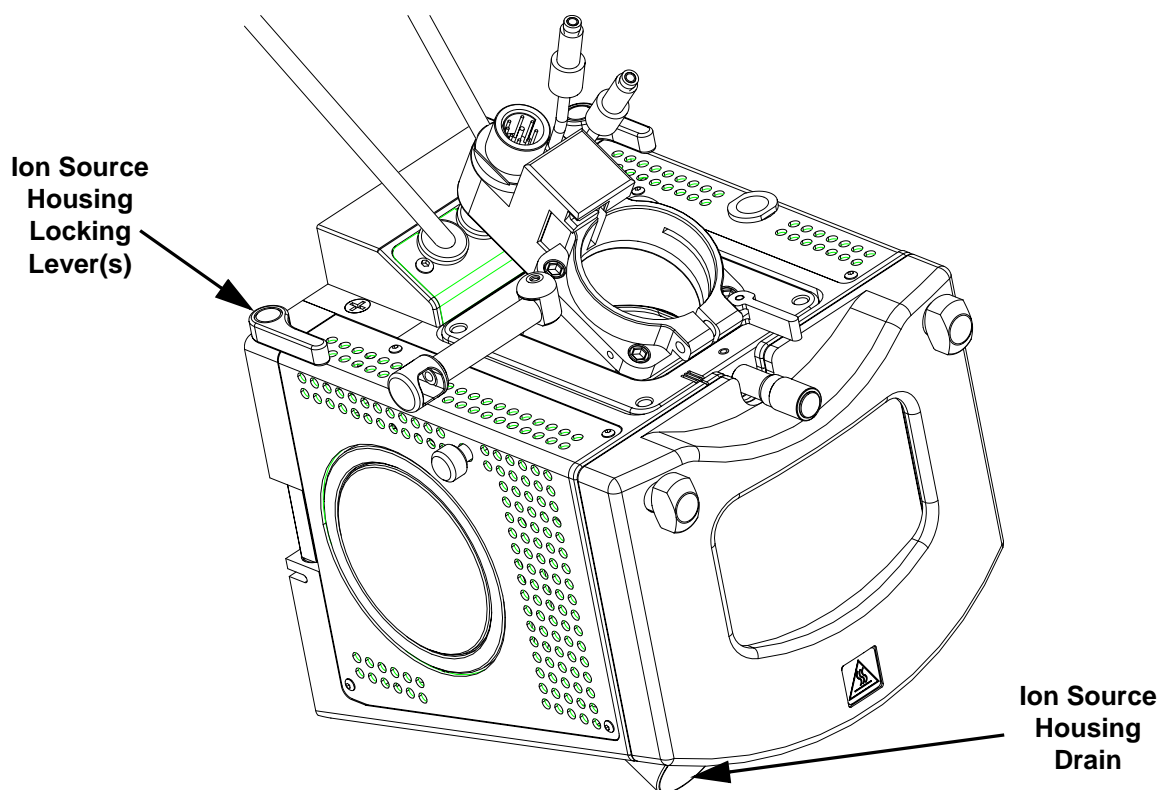

Figure 6-2. Ion Max ion source housing, detail of components

6.3 Removing the Ion Sweep Cone

Use of the ion sweep cone is optional. If you do not need to use the ion sweep cone, remove the ion sweep cone as follows:

1. Put on a pair of talc-free gloves.



CAUTION. AVOID BURNS. At operating temperatures, the ion transfer capillary can severely burn you! The ion transfer tube typically operates between 200 and 400 °C. **Always allow the ion sweep cone to cool to room temperature (for approximately 20 min) before you touch or remove this component.** Always be careful not to touch the entrance end of the ion transfer capillary when it is exposed.

2. Grasp the outer ridges of the ion sweep cone and pull the cone straight off of the API cone seal.
3. Store the ion sweep cone in its original shipping container.

The ion sweep cone is now properly removed.

If you need to install the corona needle, go to the next topic: **Installing the Corona Needle**; otherwise, go to the topic: **Installing the Ion Max Ion Source Housing** on page 6-7.

6.4 Installing the Corona Needle

Install the corona needle, from the rear of the Ion Max ion source housing, as follows:



CAUTION. AVOID INJURY. The corona discharge needle is very sharp and can puncture your skin. Handle it with care.

1. Using pliers, grasp the needle by the corona needle contact and push the needle straight into the needle socket in the Ion Max ion source housing. See Figure 6-3.

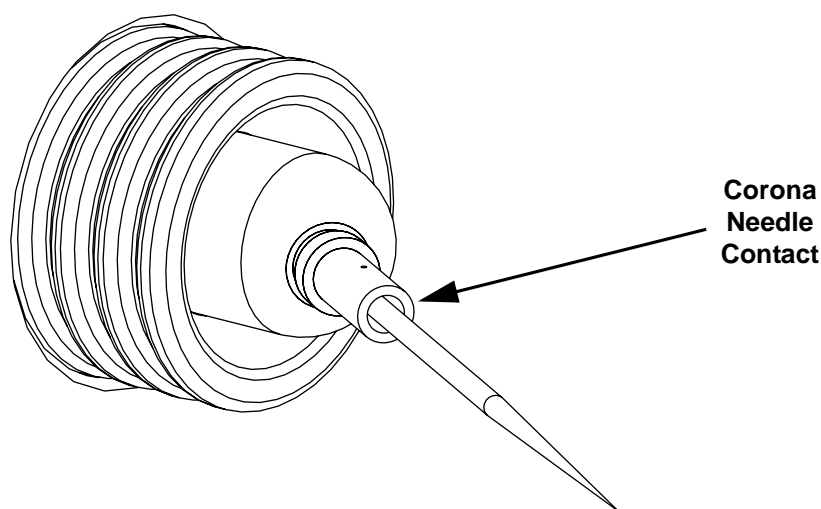

Figure 6-3. Corona needle, view from rear

2. Make sure the tip of the needle is aligned with the path of travel between the APCI probe and the ion source interface on the instrument.

The corona needle is now properly installed.

Go to the next topic: **Installing the Ion Max Ion Source Housing.**

6.5 Installing the Ion Max Ion Source Housing

Reinstall the Ion Max ion source housing as follows:

1. Carefully align the two guide pin holes on the rear of the ion source housing with the ion source housing guide pins on the MS detector, and carefully press the ion source housing onto the ion source mount. See Figure 6-4 and Figure 6-5.

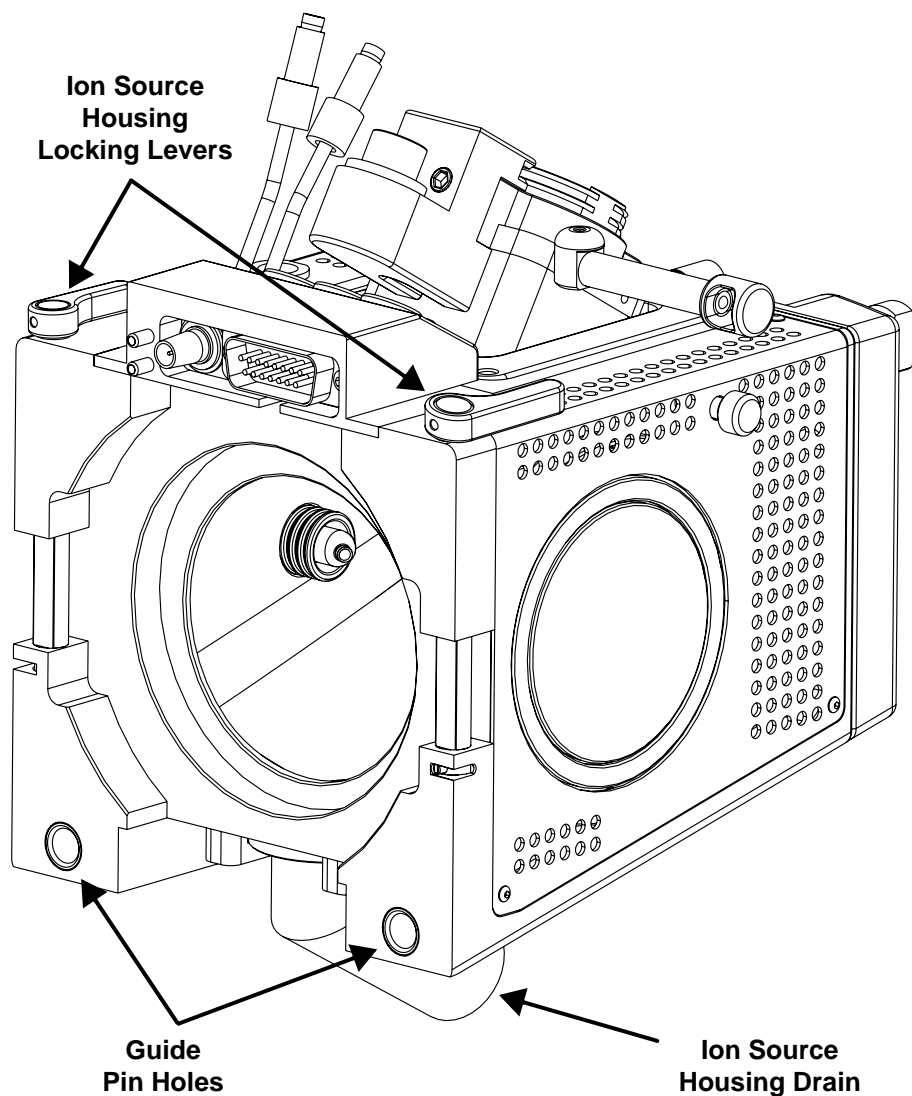

Figure 6-4. Rear view of the Ion Max ion source housing

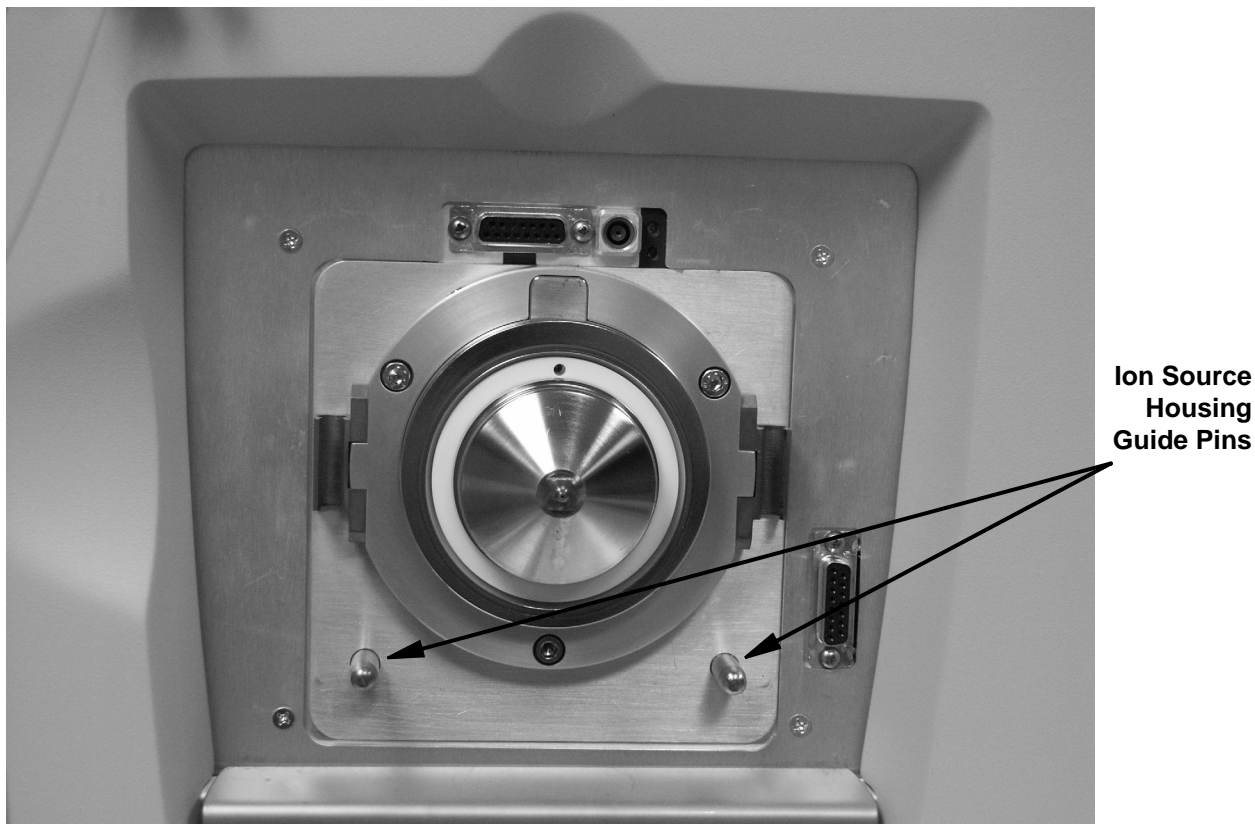

Figure 6-5. Ion source mount showing ion source housing guide pins

2. Rotate the ion source housing locking levers 90 degrees to lock the ion source housing onto the ion source mount assembly.

Caution. Prevent solvent waste from backing up into the ion source housing and MS detector. Always ensure that liquid in the drain tube is able to drain to a waste container and that the outlet of the drain tube is above the level of liquid in the waste container.

Caution. Do **not** vent the API source drain tube (or any vent tubing connected to the waste container) to the same fume exhaust system to which you have connected the forepumps. The analyzer optics can become contaminated if the API source drain tube and the (blue) forepump exhaust tubing are connected to the same fume exhaust system.

Your laboratory must be equipped with at least two fume exhaust systems. Route the (blue) forepump exhaust tubing to a dedicated fume exhaust system. Route the drain tube from the API source to a waste container. Vent the waste container to a dedicated fume exhaust system.

3. Reinstall the ion source drain tube as follows:
 - a. Connect the 1-in. ID Tygon tubing to the ion source housing drain fitting.
 - b. Attach the free end of the hose to a waste container. Ideally, the waste container should be vented to a fume exhaust system.

The Ion Max ion source housing is now properly installed on the MS detector.

Go to the next topic: **Installing the APCI Probe.**

6.6 Installing the APCI Probe

Install the APCI probe into the Ion Max ion source housing, as follows:

1. Connect the 8 kV cable to the corona needle high voltage receptacle as follows:
 - a. Plug the 8 kV cable into the corona needle high voltage receptacle on the right side of the top of the ion source housing.
 - b. Lock the cable by rotating the locking ring clockwise.
2. Be sure to unlock the probe locking lever (widest open position) before attempting to install the probe.
3. Insert the APCI probe into the port in the ion source housing, align the guide pin on the probe body at a 45 degree angle from the API interlock block. See Figure 6-6
4. Push the probe into the port until the guide pin meets with the probe collar on the ion source housing.
5. Turn the probe 45 degrees clockwise and align the guide pin with the slot in the API interlock block (you might need to pull the probe towards you slightly to properly align the pin with the notch). Once you have turned the probe far enough to align the pin with the alignment notch at the rear of the port, push the probe straight in until the guide pin stops at the bottom of the alignment notch.
6. Seat the probe all the way down into the alignment notch.

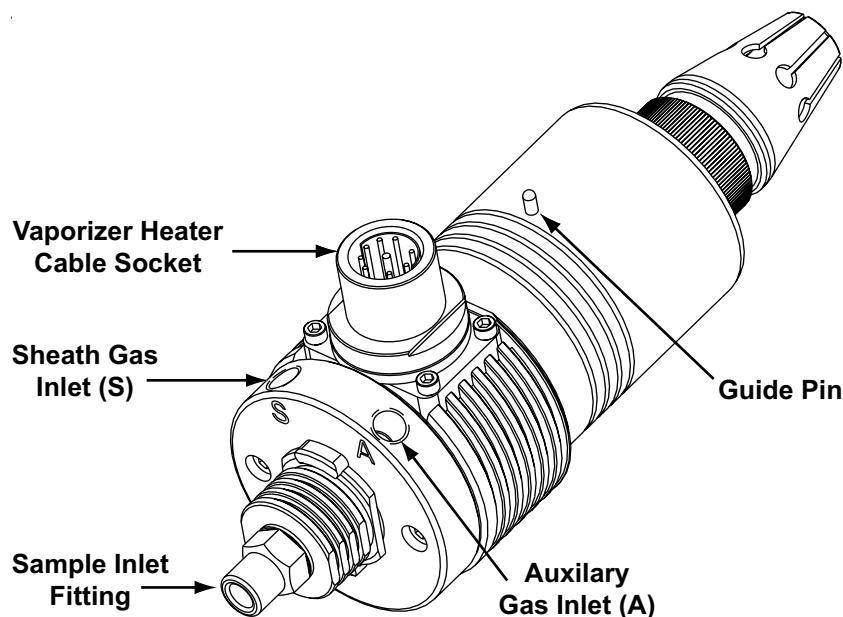

Figure 6-6. APCI probe

7. Lock the probe in place by rotating the probe locking lever towards the front of the housing; closing the probe locking lever towards the rear of the ion source housing might make it difficult to unlock.
8. Unplug the vaporizer heater cable from the ESI interlock plug on the ion source housing.
9. Connect the vaporizer heater cable to the vaporizer heater cable socket on the APCI probe.
10. Connect the sheath gas fitting (blue) to the sheath gas inlet (S) on the probe. (See Figure 6-6)
11. Connect the auxiliary gas fitting (green) to the auxiliary gas inlet (A) on the probe. (Figure 6-6)
12. Connect the sample transfer line to the APCI probe inlet.

The APCI probe is now properly installed in the Ion Max ion source housing.

Caution. Prevent solvent waste from backing up into the ion source and MS detector. Always ensure that liquid in the drain tube is able to drain to a waste container and that the outlet of the drain tube is above the level of liquid in the waste container.

Leave the LC/MS system in Standby and go to the next chapter: **Optimizing the MS Detector with Your Analyte in APCI/MS Mode.**

Chapter 7

Optimizing the MS Detector with Your Analyte in APCI/MS Mode

This chapter provides information on optimizing the tune of your MS detector in the APCI/MS high flow mode. It is not necessary to recalibrate the MS detector when you switch to APCI/MS operation. You can use the calibration settings you obtained from the successful automatic calibration procedure you performed in the ESI/MS mode.

For APCI/MS operation you simply open a default Tune Method located in your *C:\Xcalibur\methods* folder, in this case *APCIhighflow.LTQTune*. From this starting point, you optimize automatically the tube lens voltage for your particular analyte. The capillary voltage and ion transfer capillary temperature may then be optimized manually to enhance ion transmission.

Note. The following procedures assume that you are familiar with your Finnigan LTQ instrument and the Tune Plus window. If you need information, refer to the Finnigan LTQ online Help, **Finnigan LTQ Getting Connected**, and/or **Finnigan LTQ Hardware Manual**.

Ensure that you have completed the procedures in the topics **Tuning and Calibrating Automatically in the ESI/MS Mode** and **Setting Up to Acquire Data in the APCI/MS Mode**.

This chapter includes the following topics:

- Setting Up the Inlet for Tuning Using High-Flow Infusion
- Setting Up the MS Detector for APCI/MS Operation
- Optimizing the Tune of the MS Detector Automatically in APCI/MS Mode
- Saving the APCI/MS Tune Method
- Cleaning the MS Detector after Tuning in APCI Mode

7.1 Setting Up the Inlet for Tuning Using High-Flow Infusion

To make the plumbing connections for APCI/MS sample introduction from the syringe pump into solvent flow from an LC, proceed as follows:

1. Connect a 4 cm (1.5 in) segment of Teflon tubing with a (brown) fingertight fitting and a (brown) ferrule to the (black) LC union. See Figure 7-1.

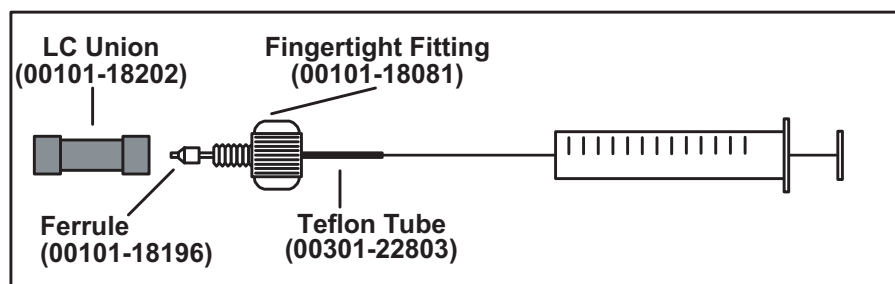

Figure 7-1. APCI/MS plumbing connections for the syringe pump

2. Load a clean, 500- μ L Unimetrics syringe with 450 μ L of a 125 fg/ μ L solution of reserpine or your analyte of interest. (Refer to **Appendix A: Sample Formulations** for a procedure for making the reserpine tuning solution.)
3. Insert the needle of a syringe into the segment of Teflon tubing, and place the syringe in the syringe holder of the syringe pump.
4. Connect a fused-silica infusion line from the (black) LC union to the (black) LC Tee union, as follows. See Figure 7-2.
 - a. Connect the infusion line with a (brown) fingertight fitting and a (brown) ferrule to the free end of the LC union.
 - b. Connect the other end of the infusion line with a (red) fingertight fitting and a (brown) ferrule to the side arm of the LC Tee union.

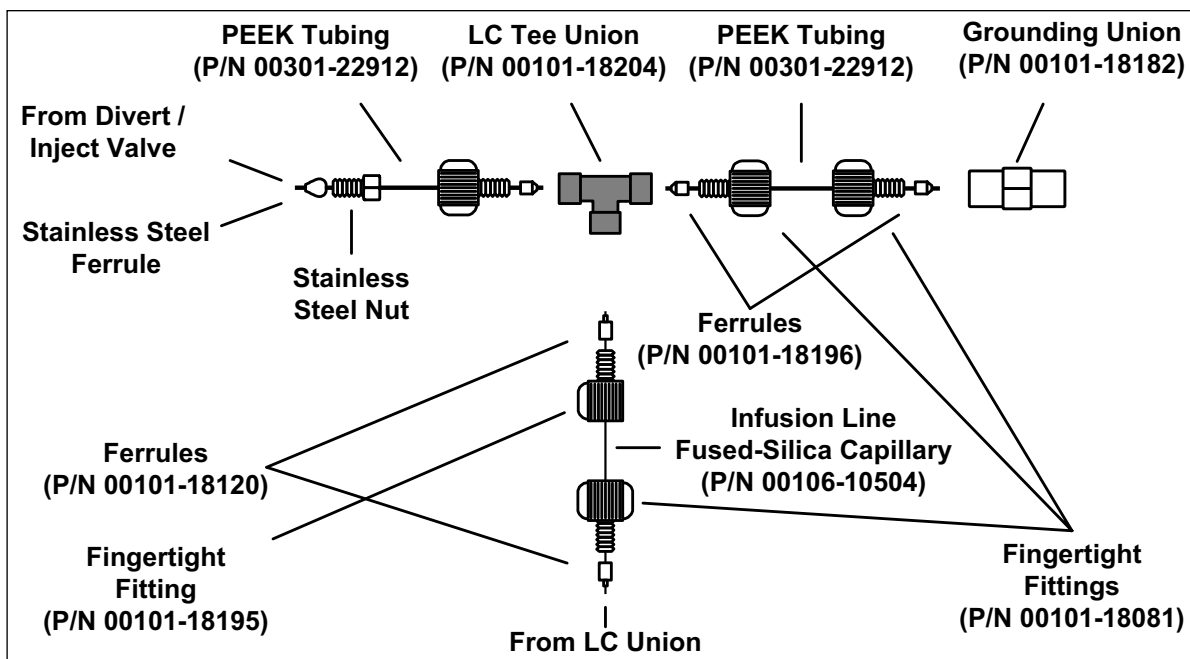

Figure 7-2. APCI/MS plumbing connections for the LC Tee union

Note. To cut the PEEK tubing used to connect your LC to the divert/inject valve and the divert/inject valve to the APCI source, use a PEEK tubing cutter. This ensures that the tubing is cut straight. In addition, make sure your LC fittings, ferrules, and PEEK tubing are installed properly. By using these precautions, you prevent void (dead) volumes. The exclusion of void volumes is critical to microbore LC. Also, void volumes affect the quality of the MS detector signal.

5. Connect a segment of PEEK tubing from the (black) LC Tee union to the APCI LC inlet, as follows. (See Figure 7-2.)
 - a. Use a PEEK tubing cutter to cut a 4 cm (1.5 in.) length of the PEEK tubing.
 - b. Connect the PEEK tubing with a (brown) fingertight fitting and a (brown) ferrule to a free end of the (black) LC Tee union.
 - c. Connect the other end of the PEEK tubing with a (red) fingertight fitting and a (brown) ferrule to the LC inlet located on the APCI probe.

6. Connect an appropriate length of PEEK tubing (transfer line from the divert/inject valve) from the divert/inject valve to the LC Tee union, as follows. (See Figure 7-2.)
 - a. Connect a length of PEEK tubing with a (stainless steel) nut and a (stainless steel) ferrule to port 3 of the divert/inject valve.
 - b. Connect the other end of the PEEK tubing with a (brown) fingertight fitting and a (brown) ferrule to the free end of the LC Tee union.
7. Connect an appropriate length of PEEK tubing (transfer line from the LC) from the divert/inject valve to the LC, as follows:
 - a. Connect a length of PEEK tubing with a (stainless steel) nut and a (stainless steel) ferrule to port 2 of the divert/inject valve.
 - b. Connect the other end of the PEEK tubing with a proper fitting and a ferrule to the outlet of the LC.
8. Connect an appropriate length of PEEK tubing (waste line) from the divert/inject valve to a waste container, as follows:
 - a. Connect a length of PEEK tubing with a (stainless steel) nut and a (stainless steel) ferrule to port 1 of the divert/inject valve.
 - b. Insert the other end of the PEEK tubing in a suitable waste container.

The LC plumbing connections are now properly made for APCI/MS sample introduction from the syringe pump into solvent flow from an LC.

Go to the next topic: **Setting Up the MS Detector for APCI/MS Operation.**

7.2 Setting Up the MS Detector for APCI/MS Operation

Use the following procedure to set up the MS detector for APCI/MS operation on the Finnigan LTQ MS detector.



On



Standby

1. In Tune Plus, click on the On/Standby button to take the MS detector out of Standby mode and turn it On. The MS detector begins scanning, and the Finnigan LTQ MS detector applies high voltage to the corona needle and shows a real-time display in the Spectrum view.
2. Open the *APCIhighflow.LTQTune* Tune Method, the Tune Method for high-flow APCI operation, as follows:
 - a. Choose **File > Open** to display the Open dialog box.
 - b. Scroll down until you see the folder *C:\Xcalibur\methods*. Then, select the file *APCIhighflow.LTQTune*.
 - c. Click on **OK** to open the file. Finnigan LTQ MS detector downloads the Tune Method parameters to the MS detector.
3. Verify that the Finnigan LTQ MS detector opened the Tune Method, as follows:
 - a. On the Instrument Setup toolbar, click on the API Source button to open the APCI Source dialog box. See Figure 7-3.

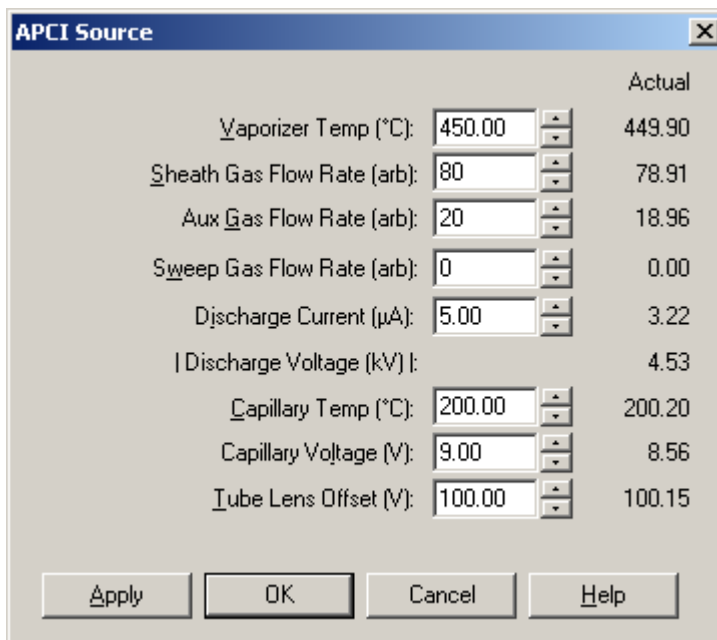
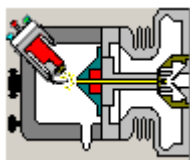

Figure 7-3. APCI Source dialog box, showing the proper settings for a typical high flow experiment

- b. Verify that the settings in your dialog box are similar to those shown in Figure 7-3.
 - c. Click on **OK** to close the APCI Source dialog box.
4. Define the scan parameters for tuning the MS detector in the APCI/MS mode, as follows:
- a. On the Control/Scan Mode toolbar, click on the Define Scan button to open the Define Scan dialog box. Figure 7-4 (If your dialog box appears different from the one shown in the figure, it is probably because the advanced settings are not displayed. You can turn on the advanced settings as follows: In Tune Plus, choose **ScanMode**, and then click on *Advanced Scan Features* to select the option.)
 - b. In the Scan Description group box, in the Mass Range list box, select *Normal* to allow for a selection of mass ranges between m/z 150 to 2000.
 - c. In the Scan Rate list box, select *Normal* to specify a normal scan rate.
 - d. In the Scan Type list box, select *SIM* to specify a selected ion monitoring scan.
 - e. In the Scan Time group box, in the Microscans spin box, enter **1** to set the total number of microscans to 1.
 - f. In the Max. Inject Time spin box, enter *200.000* to specify a 200 ms maximum injection time.

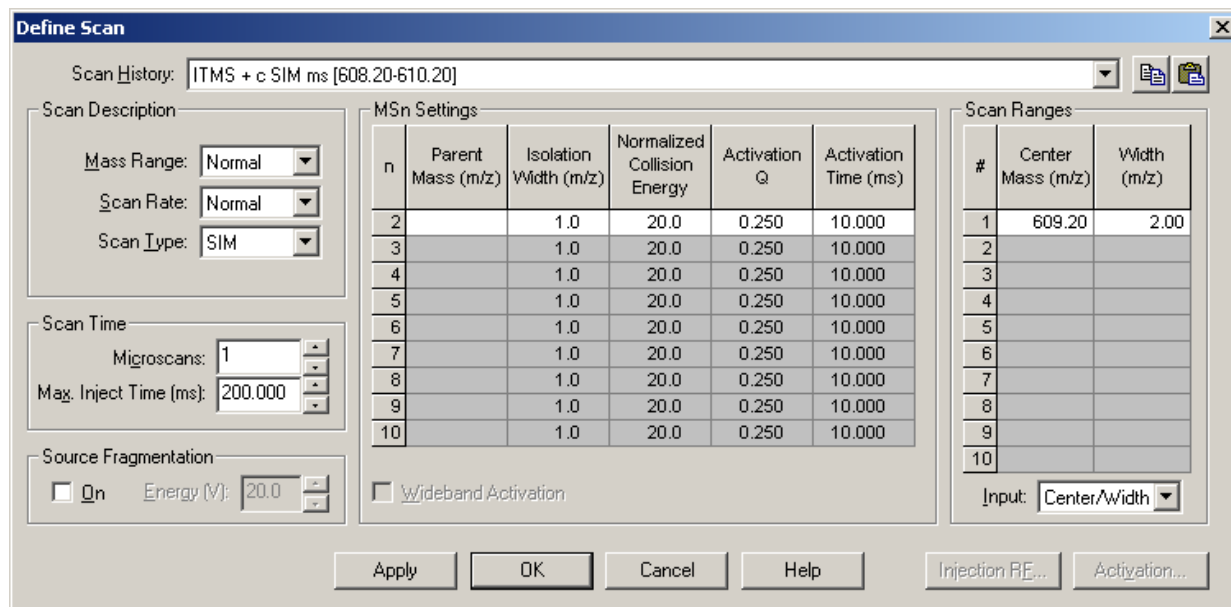

Figure 7-4. Define Scan dialog box, showing typical settings for APCI/MS operation

- g. In the Source Fragmentation group box, confirm that the On check box is not selected () to specify that the ion source fragmentation option is turned off.
- h. In the Scan Ranges group box, in the Input list box, select *Center/Width* to make available the Center Mass and Width text boxes in the Scan Ranges table.
- i. In the Scan Ranges group box, in the Scan Ranges table, in the Center Mass text box, enter **609.20** to set the center mass for the scan range to m/z 609.20.
- j. In the Width text box, enter **2.00** to set the width of the scan range to m/z 2.00.
- k. Ensure that the settings in your Define Scan dialog box are the same as those shown in Figure 7-4.
- l. Click on **OK** to apply the MS detector scan parameters and to close the Define Scan dialog box.



5. On the Control/Scan Mode toolbar, click on the Centroid/Profile button to toggle the data type to centroid. (The picture on the button should be the same as that shown here).



6. Click on the Positive/Negative button to toggle the ion polarity mode to positive. (The picture on the button should be the same as that shown here).

You have now completed setting up your MS detector for APCI/MS operation. Go to the next topic: **Optimizing the Tune of the MS Detector Automatically in APCI/MS Mode.**

7.3 Optimizing the Tune of the MS Detector Automatically in APCI/MS Mode

You can optimize the tune of the MS detector automatically for APCI operation.

The most important parameters that affect the signal quality during APCI/MS operation are the vaporizer temperature, ion transfer tube temperature, API gas flows, and solution flow rate. If any one of these parameters is changed, you need to re-optimize MS detector parameters. (You can use the Semi-Automatic tune procedure to tune the MS detector on individual parameters.)

Use the following procedure to optimize the MS detector automatically on the reserpine peak at m/z 609.2 at your particular flow rate, for example, 400 $\mu\text{L}/\text{min}$. (Refer to Table 1-2 on page 1-12 for guidelines about flow rates and temperatures.)



1. On the Control/Scan Mode toolbar, click on the Tune button to display the Automatic tuning page. See Figure 7-5.
2. In the What to Optimize On group box, select the Mass option button to make active the Mass spin box.
3. In the Mass spin box, enter **609.2** to specify that you want to tune on the peak at m/z 609.2.



4. Ensure that the Divert/Inject valve is in the Detector position, as follows:
 - a. Click on the Divert/Inject Valve button to open the Divert/Inject Valve dialog box.
 - b. Select the Detector option button, and then click on **Close** to return to Tune Plus.

5. Start the automatic tuning procedure from the Tune dialog box, as follows:
 - a. Click on **Start**. A message box displays the following message:
Please ensure that the 500 microliter syringe is full.

Ensure the syringe pump contains at least 450 μL of the 125 $\text{fg}/\mu\text{L}$ reserpine tuning solution.

- b. Click on **OK** to close the message box, and return to the Tune Plus window.



6. On the File/Display toolbar, click on the Graph View button to display the view.

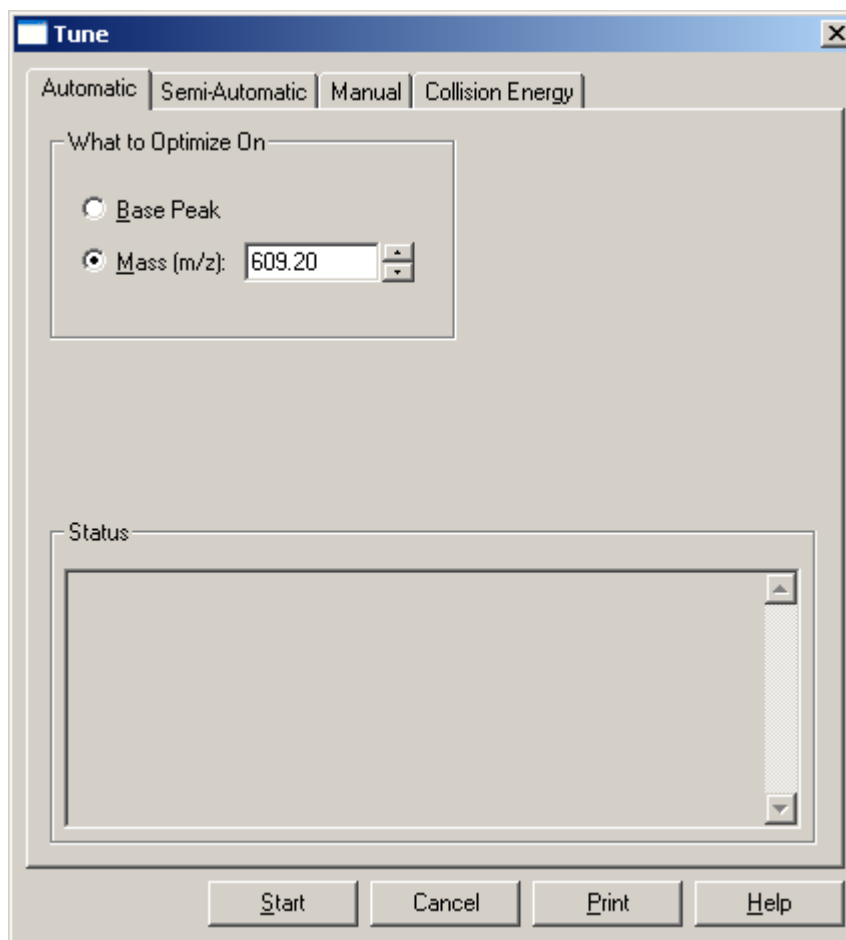

Figure 7-5. Tune dialog box, showing the Automatic tuning page

7. Observe the Tune Plus window and the Tune dialog box. While automatic tuning is in progress, the Finnigan LTQ MS detector displays various tests in the Spectrum and Graph views in the Tune Plus window and displays various messages in the Status group box in the Tune dialog box. Your Tune Plus window should now look similar to the one shown in Figure 7-6.

You have now successfully tuned the MS detector in APCI/MS mode for the compound reserpine (or your analyte of interest). Leave the LC pumps on (with a flow rate of approximately 400 $\mu\text{L}/\text{min}$), and leave the Tune Plus window open with *APCIhighflow.LTQTune* to complete the next topic: **Saving the APCI/MS Tune Method.**

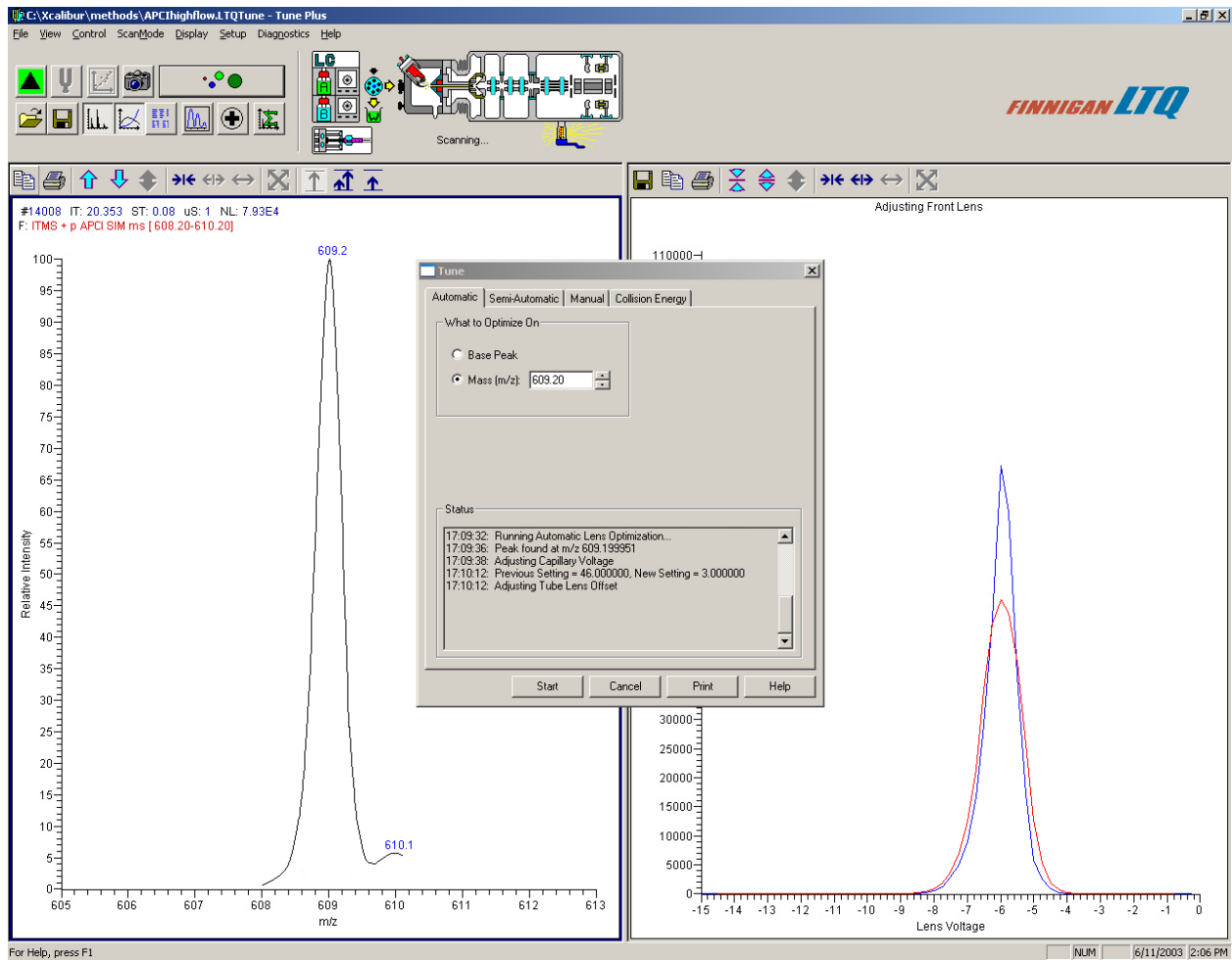

Figure 7-6. Tune Plus window with the Tune dialog box, showing the Automatic tuning page

7.4 Saving the APCI/MS Tune Method

You can save the settings you just obtained in a Tune Method specific to your particular analyte and solvent flow rate. (In this case, you save settings obtained using reserpine.) You can recall the Tune Method and use it as a starting point for optimizing the MS detector on reserpine at a different flow rate.

Note. Save the Tune Method while the MS detector is still On.

Save your APCI/MS Tune Method, as follows:

1. Choose **File > Save As** to display the Save As dialog box. See Figure 7-7.
2. Select the *C:\Xcalibur\methods* folder.
3. Click on the File Name text box, and then enter **APCImyTune** to name the Tune Method *APCImyTune.LTQTune*.

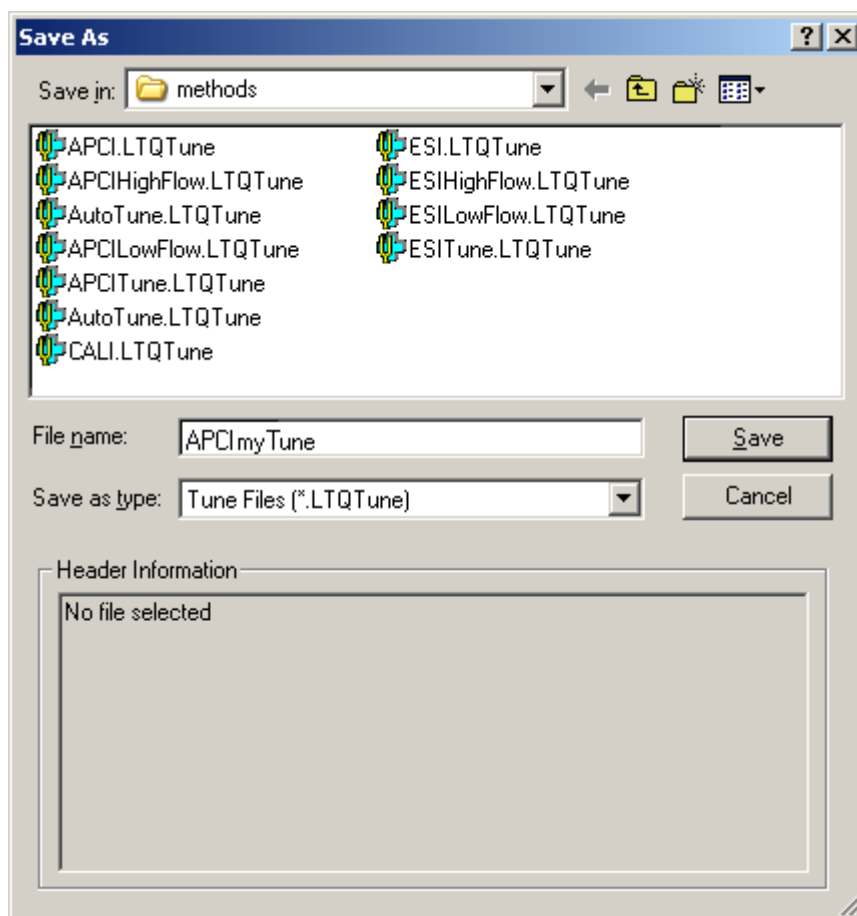

Figure 7-7. Save As dialog box, showing files in the folder *C:\Xcalibur\methods*

4. Click on **Save** to save the Tune Method and close the Save As dialog box. Note that the Tune Method is named *APCImyTune.LTQTune*.

Before you acquire data, go to the next topic: **Cleaning the MS Detector after Tuning in APCI Mode**.

7.5 Cleaning the MS Detector after Tuning in APCI Mode

Use the following procedure to clean the MS detector after tuning on your analyte of interest.



On



Standby



1. Click on the On/Standby button to put the MS detector in Standby mode. When the MS detector is in Standby, the Finnigan LTQ MS detector turns off the vaporizer heater, corona discharge voltage, and syringe pump. The MS detector stops scanning, and the Finnigan LTQ MS detector freezes the displays for the Spectrum and Graph views.

CAUTION. Always place the MS detector in Standby (or Off) before you open the API source to atmospheric oxygen. The presence of oxygen in the ion source when the MS detector is On could be unsafe. (The Finnigan LTQ MS detector automatically turns Off when you open the API source, however, it is best to take this added precaution.)

2. Remove the syringe from the syringe pump holder, as follows:
 - a. Squeeze the blue buttons, and pull back on the syringe pump handle to free the syringe.
 - b. Remove the syringe from the holder.
 - c. Disconnect the tip of the syringe needle from the Teflon tubing.
3. Clean the syringe thoroughly, as follows:
 - a. Clean the syringe with a solution of 5% formic acid in water.
 - b. Rinse the syringe with a solution of 50:50 methanol:water.
 - c. Use acetone to rinse the syringe. (Repeat this step several times.)



CAUTION. AVOID BURNS. The APCI vaporizer heater can reach temperatures of 600 °C. **Always allow the APCI probe to cool to ambient temperature, for approximately 20 min, before handling or removing the APCI probe from the APCI flange.**



CAUTION. AVOID INJURY. The corona discharge needle is very sharp and can puncture your skin if you handle it without caution.

4. Remove the Ion Max ion source housing as described in the topic **Removing the Ion Max Ion Source Housing** on page 2-6.

5. Flush the sample transfer line, sample tube, and APCI probe thoroughly with a solution of 5% formic acid in water (or with another appropriate solvent), as follows:

Note. The solvent that you use to flush the sample transfer line, sample tube, and APCI probe assembly depends on the solvent system you use to dissolve your samples. For example, if you are using a buffered solution of a high concentration, an acidic solution is appropriate.

- a. Fill a clean, 250 μ L Unimetrics syringe with an appropriate solvent.
 - b. While holding the plunger of the syringe in place, carefully insert the needle of the syringe into the free end of the Teflon tube.
 - c. Flush the sample transfer line, sample tube, and APCI probe with the solution by slowly depressing the syringe plunger. Visually check that the solution is exiting the tip of the APCI probe on the inside of the probe assembly. Use a lint-free tissue to gently remove the excess solution as it exits the probe.
 - d. Remove the needle of the syringe from the Teflon tube.
6. Repeat step 5 with a solution of 50:50 methanol:water.
 7. Reinstall the Ion Max ion source housing as described in topic **Installing the Ion Max Ion Source Housing** on page 2-9.

If you plan to run analytical samples in APCI mode, go to the next chapter: **Acquiring APCI Sample Data Using the Tune Plus Window.**

Chapter 8

Acquiring APCI Sample Data Using the Tune Plus Window

This chapter provides information on acquiring LC/APCI/MS sample data using the Tune Plus window. This experiment uses reserpine but you can follow the same procedure with your analyte of interest.

Note. The following procedures assume that you are familiar with your Finnigan LTQ instrument and the Tune Plus window. If you need information, refer to the Finnigan LTQ online Help, **Finnigan LTQ Getting Connected**, and/or **Finnigan LTQ Hardware Manual**. Ensure that you have completed the procedures in the chapters **Tuning and Calibrating Automatically in the ESI/MS Mode** and **Optimizing the MS Detector with Your Analyte in APCI/MS Mode**.

This chapter contains the following topics:

- Setting Up to Introduce Sample by Loop Injection into Solvent Flow from an LC
- Acquiring APCI Data in the SIM Scan Mode

8.1 Setting Up to Introduce Sample by Loop Injection into Solvent Flow from an LC

This topic provides information on how to introduce sample by loop injection into solvent flow from an LC.

Make the plumbing connections as follows:

1. Connect an appropriate length of (red) PEEK tubing (transfer line from the divert/inject valve) from port 3 of the divert/inject valve to the (stainless steel) sample inlet fitting on the APCI probe. See Figure 8-1 and Figure 8-2.
2. Connect a 5 μ L sample loop with (stainless steel) set nuts and (stainless steel) ferrules to ports 1 and 4 of the divert/inject valve.
3. Connect an appropriate length of PEEK tubing (transfer line from the LC) from the divert/inject valve to the LC, as follows:
 - a. Connect a length of the PEEK tubing with a (stainless steel) nut and (stainless steel) ferrule to port 2 of the divert/inject valve.
 - b. Connect the other end of the PEEK tubing with a proper fitting and a ferrule to the outlet of the LC.

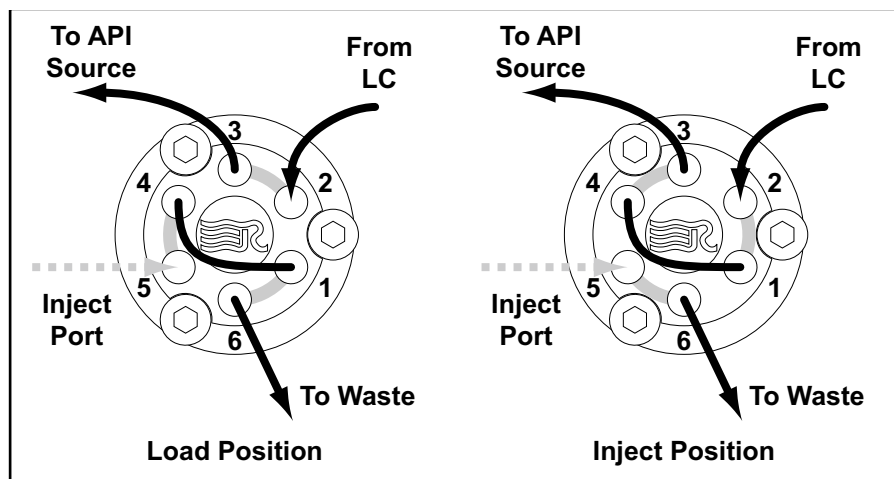

Figure 8-1. Divert/Inject valve, showing the correct setup for analysis by loop injection and showing the flow of liquid through the valve in the Load and Inject positions

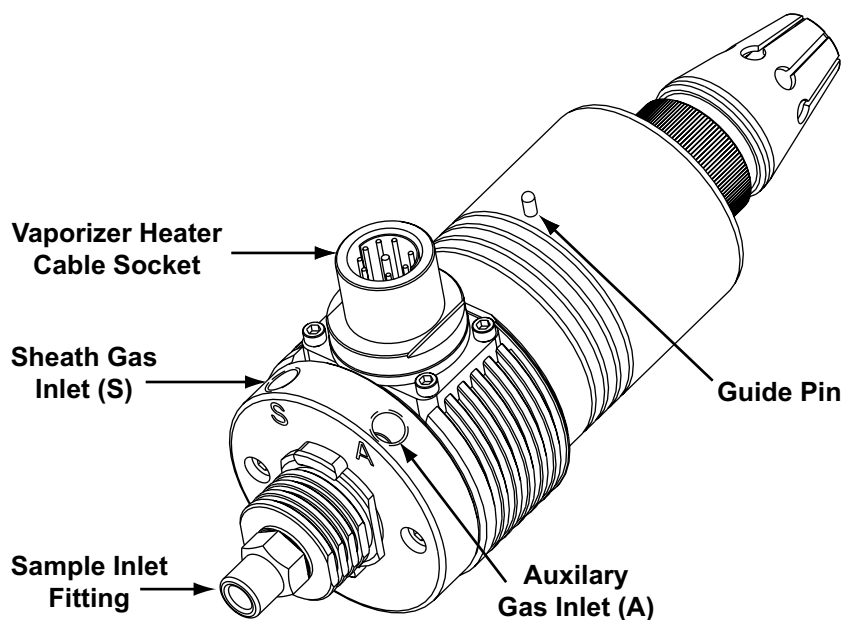

Figure 8-2. APCI probe

4. Connect an appropriate length of PEEK tubing (waste line) from the divert/inject valve to a waste container, as follows:
 - a. Connect a length of PEEK tubing with a (stainless steel) nut and (stainless steel) ferrule to port 6 of the divert/inject valve.
 - b. Insert the other end of the PEEK tubing into a suitable waste container.

The MS detector is now set up to introduce sample by loop injection into solvent flow from an LC.

Go to the next topic: **Acquiring APCI Data in the SIM Scan Mode.**

8.2 Acquiring APCI Data in the SIM Scan Mode

Use the following procedure to acquire a file of reserpine data in the selected ion monitoring (SIM) mode. The Finnigan LTQ MS detector automatically saves the data you acquire on your hard disk.



On



Standby



1. If you have not already done so, in Tune Plus, click on the On/Standby button to take the MS detector out of Standby mode and turn it On. The MS detector begins scanning, and the Finnigan LTQ MS detector applies high voltage to the corona needle and shows a real-time display in the Spectrum view.
2. Ensure that the Centroid data type is selected. (The picture on the button should be the same as that shown here.)
3. Ensure that the scan parameters are defined to acquire SIM data for reserpine (or your analyte of interest), as follows:
 - a. Click on the Define Scan button to open the Define Scan dialog box. Figure 8-3
 - b. Ensure that the values in your dialog box are the same as those in Figure 8-3. Then, click on **OK**.

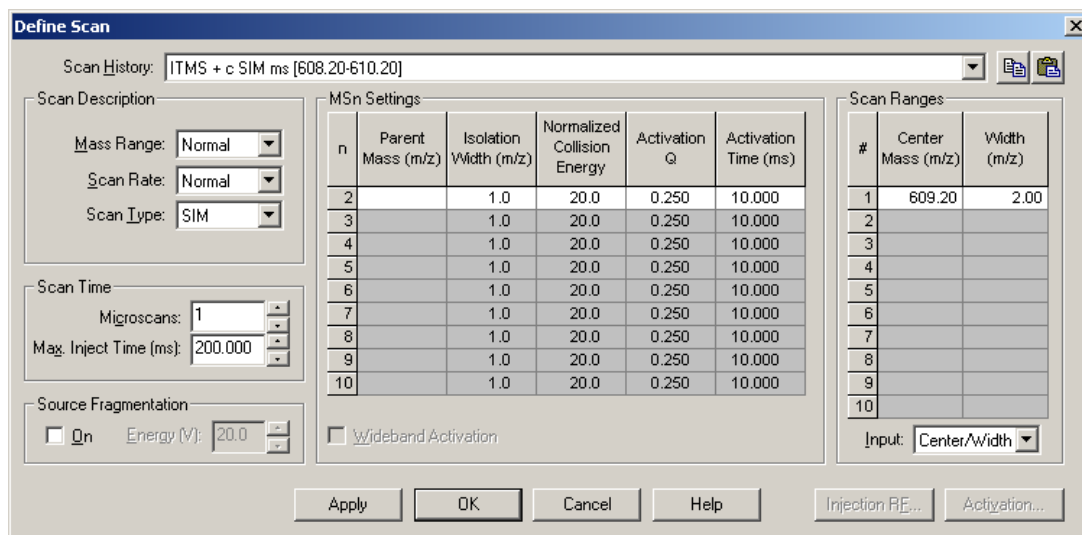

Figure 8-3. Define Scan dialog box, showing typical settings for acquiring data in the SIM scan mode



4. Turn on your LC pump, and specify an appropriate flow rate of 400 µL/min, for example. Ensure that your system is free of leaks.
5. On the Control/Scan Mode toolbar, click on the Acquire Data button to open the Acquire Data dialog box. See Figure 8-4.
6. Specify the acquisition parameters, as follows:
 - a. In the File Name text box, enter **reserpine** to specify a filename.
 - b. In the Sample Name text box, enter **reserpine** to specify the sample identity. If you are not using reserpine, type the name of your particular analyte.
 - c. In the Comment text box, enter a comment about your experiment. For example, enter **SIM, APCI, 50 pg, loop** to specify the scan mode, ionization mode, sample amount, and/or method of sample introduction. The Xcalibur data system includes the comment on hard copies of your data.
 - d. In the Acquire Time group box, select the Continuously option button to specify the continuous acquisition of data (until you stop the acquisition).
7. Leave the Acquire Data dialog box open during data acquisition, but move it to a corner of the Tune Plus window.
8. Click on **Start** in the Acquire Data dialog box to begin acquiring data to the file *reserpine3.raw*. See Figure 8-5. The Acquisition Status group box displays the following message.

State: Acquiring

Time (min):

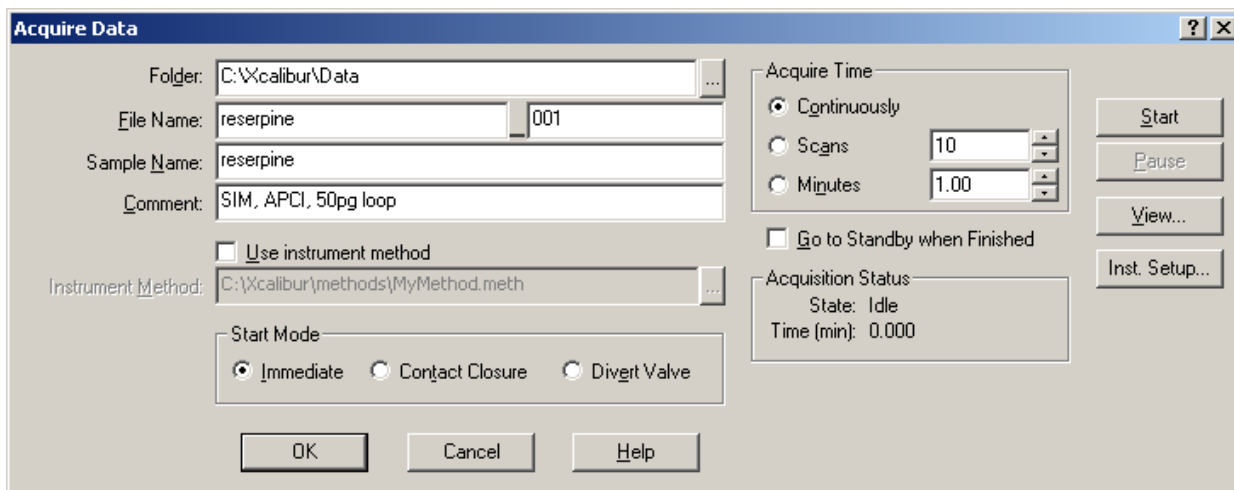

Figure 8-4. Acquire Data dialog box, showing the acquisition status of the raw data file

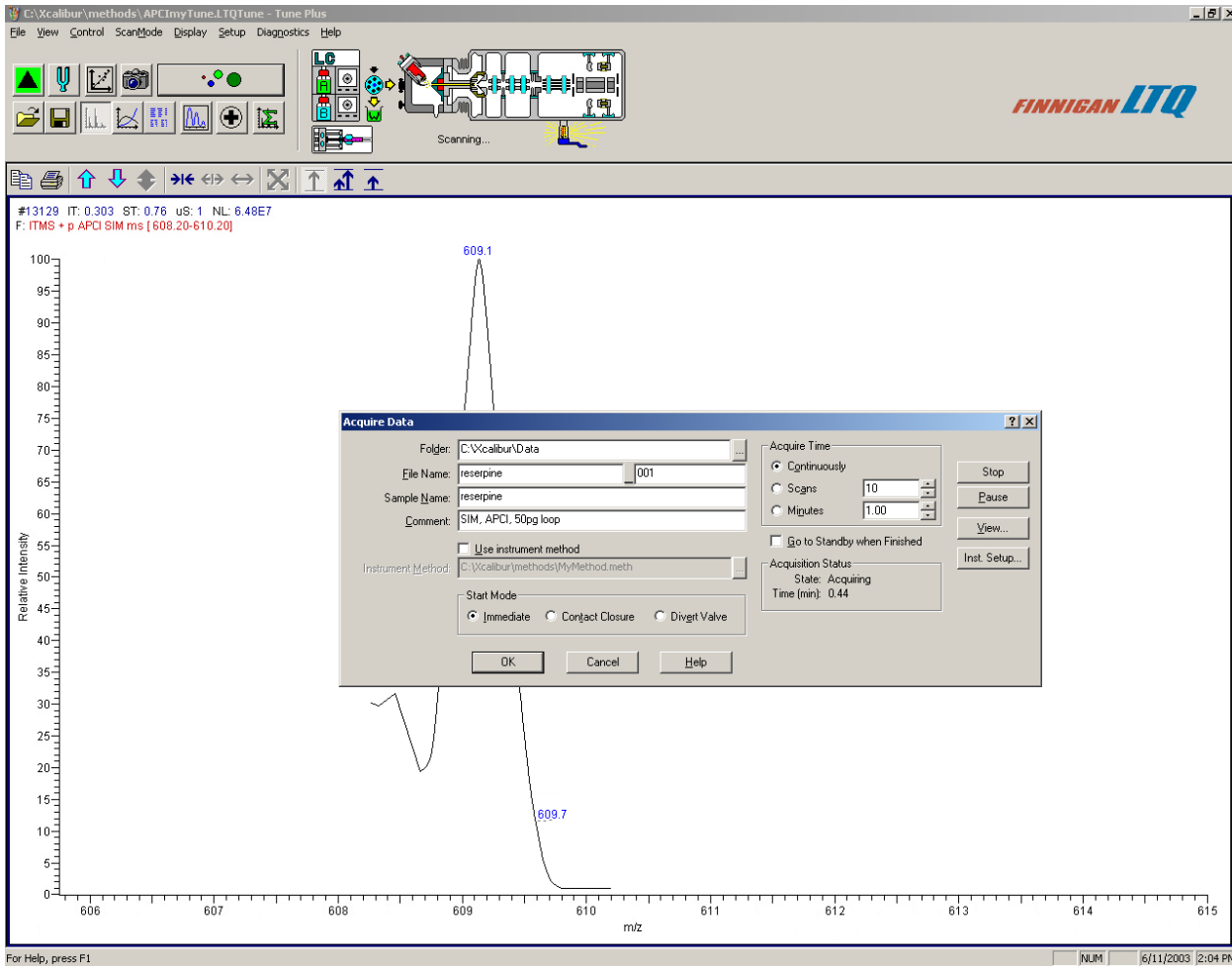
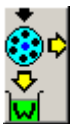

Figure 8-5. Tune Plus window, showing the SIM spectrum of reserpine during analysis by loop injection



9. Inject the reserpine solution into the APCI source from the Instrument Setup toolbar, as follows:
 - a. Click on the Divert/Inject Valve button to display the Divert/Inject Valve dialog box. See Figure 8-6.

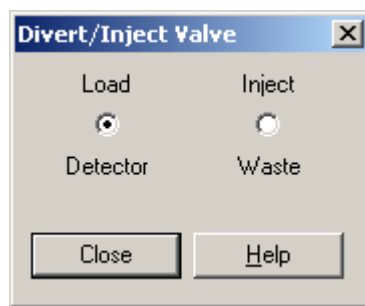

Figure 8-6. Divert/Inject Valve dialog box

- b. Select the Load option button, and overfill the 5- μ L injector loop with the 125 fg/ μ L solution of reserpine (or a solution of your analyte of interest).
 - c. Select the Inject option button.
10. Observe the reserpine peak (m/z 609.2), or that of your analyte of interest, in the Spectrum view.
11. Perform the following repetitive sequence to obtain a total of four consecutive loop injections of reserpine in the SIM scan mode. Wait about 1 min between injections.
 - a. Select the Load option button to put the divert/inject valve in the Load position. Overfill the injector loop with the 125 fg/ μ L solution of reserpine.
 - b. Select the Inject option button to inject the reserpine solution into the APCI source. Then, observe the Spectrum view.
 - c. Wait 1 min before the next injection.
 - d. Repeat step 11.a through step 11.c three times
12. Click on **Stop** in the Acquire Data dialog box to end the data acquisition.

Review the mass spectrum and chromatogram in the raw file you just acquired using the Xcalibur Qual Browser window. See Figure 8-7.

For more information about reviewing the data you acquire using the Finnigan LTQ MS detector with the Xcalibur data system, refer to the manual: **Xcalibur Getting Productive: Qualitative Analysis**.

Note. If you want to acquire MS/MS Full scan data in APCI mode, refer to the following topic for information about setting up the Finnigan LTQ MS detector: **Setting Up to Acquire MS/MS Data in the Full Scan Type**.

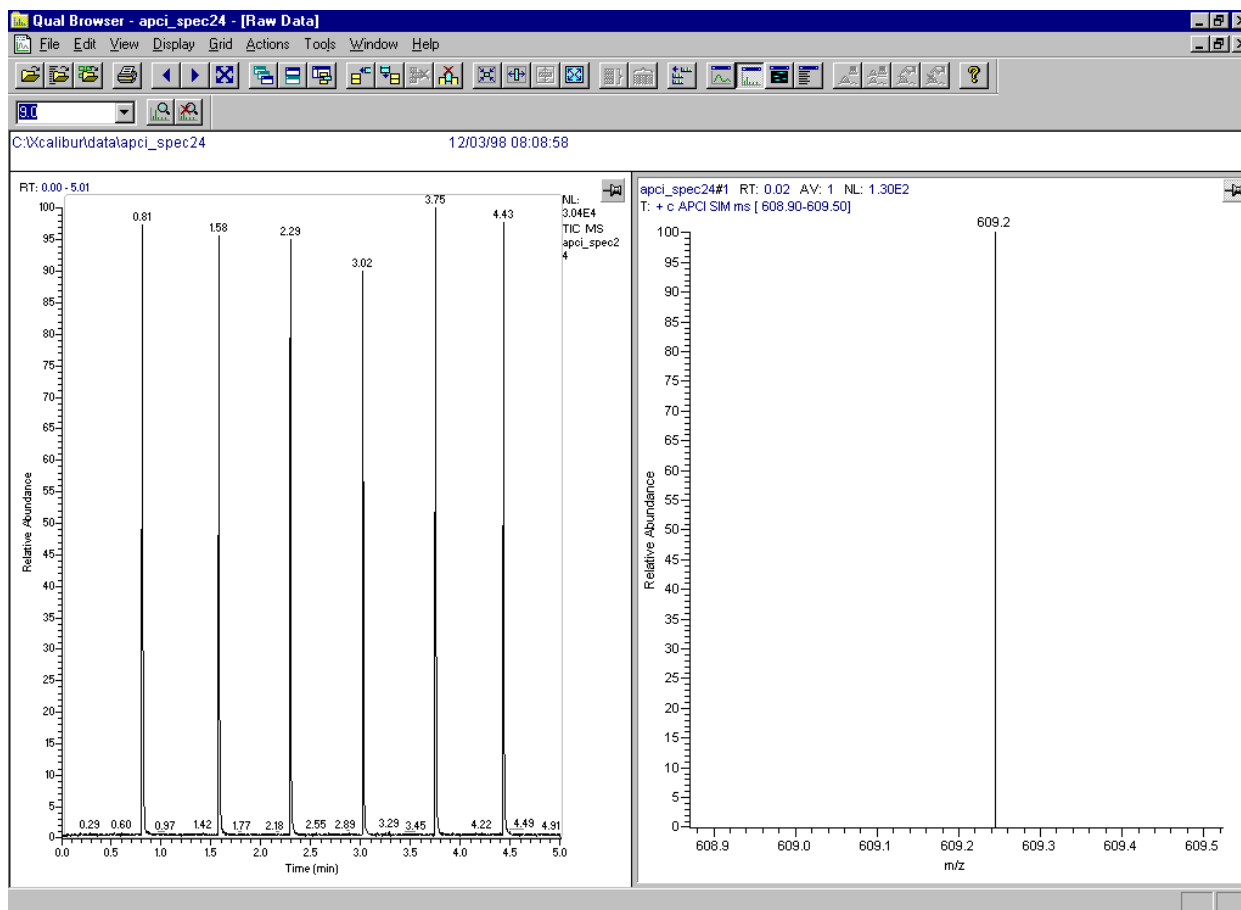

Figure 8-7. Qual Browser window, showing loop injections of reserpine in the Chromatogram view (left) and m/z 609 in the Spectrum view

Appendix A

Sample Formulations

This appendix provides instructions for the preparation of several stock solutions. These solutions are used for tuning, calibrating, and demonstrating applications of the APCI / ESI system. Formulations for sample solutions in this appendix are as follows:

- Caffeine, MRFA, and Ultramark 1621 Stock Solutions
- ESI Calibration Solution: Caffeine, MRFA, Ultramark 1621
- Reserpine

Always take safety precautions when you handle chemicals and unknown samples. **ENSURE THAT YOU READ AND UNDERSTAND THE HAZARDS OF THE CHEMICALS USED IN THE FOLLOWING PREPARATIONS.** Dispose of all laboratory reagents by the appropriate method for a specific reagent or solvent.

Material Safety Data Sheets (MSDS) provide summarized information on the hazard and toxicity of specific chemical compounds. MSDSs also provide information on the proper handling of compounds, first aid for accidental exposure, and procedures for the remedy of spills or leaks. Producers and suppliers of chemical compounds are required by law to provide their customers with the most current health and safety information in the form of an MSDS. Read the material safety data sheets for each chemical you use. Examples of potentially hazardous chemicals used in procedures throughout this manual are as follows:

- Acetic acid
- Acetonitrile
- Methanol
- Reserpine
- Formic Acid

A.1 Caffeine, MRFA, and Ultramark 1621 Stock Solutions

For tuning and calibrating the ESI system, you use a solution of caffeine, MRFA, and Ultramark 1621 in an acetonitrile:methanol:water solution containing 1% acetic acid. You prepare the calibration solution from each of the following:

- Caffeine stock solution
- MRFA stock solution
- Ultramark 1621 stock solution

Note. Vials of caffeine, MRFA, and Ultramark 1621 are included in the API accessory kit. To order more of these compounds, write or call:

Sigma Chemical Company
P. O. Box 14508
St. Louis, Missouri, USA 63178-9916
(800) 325-3010 (in the USA or Canada)
(314) 771-3750 (outside the USA or Canada)

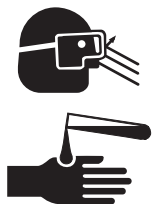

CAUTION. AVOID EXPOSURE TO POTENTIALLY HARMFUL MATERIALS. Always wear protective gloves and safety glasses when you use solvents or corrosives. Also contain waste streams, and use proper ventilation. Refer to your supplier's Material Safety Data Sheet (MSDS) for the proper handling of a particular solvent.

Stock Solution: Caffeine

A 1 mg/mL stock solution of caffeine in 100% methanol is provided with your Finnigan LTQ system.

Stock Solution: MRFA

Prepare a 1.5 mL stock solution of 166.7 pmol/ μ L MRFA in 50:50 methanol:water as follows:

1. Obtain the vial of L-methionyl-arginyl-phenylalanyl-alanine acetate·H₂O (MRFA) in your accessory kit. In this form, the MRFA sample has an average molecular weight of 607.7 u. Carefully weigh 2.6 mg of the MRFA sample.
2. Dissolve the MRFA sample in a total volume of 1.0 mL of 50:50 methanol:water.
3. Mix the solution (5.0 nmol/ μ L) thoroughly.

4. Transfer 50 μL of the 5 nmol/ μL solution into a clean polypropylene tube.
5. Add 1.45 mL of 50:50 methanol:water to the tube.
6. Mix this solution (166.7 pmol/ μL) thoroughly.
7. Label the tube *MRFA stock solution*.

Stock Solution: Ultramark 1621

Prepare a 10 mL stock solution of 0.1% Ultramark 1621 in acetonitrile as follows:

1. Obtain the vial of Ultramark 1621 in your accessory kit.
2. Using a syringe, measure out 10 μL of Ultramark 1621, and dissolve it in 10 mL of acetonitrile.
3. Mix the solution thoroughly.
4. Label the vial *Ultramark 1621 stock solution*.

Go to the next topic: **ESI Calibration Solution: Caffeine, MRFA, Ultramark 1621.**

A.2 ESI Calibration Solution: Caffeine, MRFA, Ultramark 1621

Prepare 10 mL of the calibration solution, as follows:

1. Pipet 200 μL of the stock solution of caffeine into a clean, dry 10 mL volumetric flask.
2. Pipet 100 μL of the stock solution of MRFA into the flask.
3. Pipet 100 μL of the stock solution of Ultramark 1621 into the flask.

Note. Use only glass pipets or stainless steel syringes when measuring glacial acetic acid. Using plastic pipet tips causes contamination of acid stock solutions that can introduce contaminants in the calibration solution.

4. Pipet 100 μL of glacial acetic acid into the flask.
5. Pipet 5 mL of acetonitrile into the flask.
6. Bring the volume of the solution up to the 10 mL-mark on the flask with 50:50 methanol:water.
7. Mix the calibration solution thoroughly.
8. Transfer the solution to a clean, dry vial.
9. Label the vial *ESI Calibration Solution* and store it in a refrigerator until it is needed.

A.3 Reserpine

Follow the directions given below to prepare a stock solution of reserpine. Then, use serial dilutions of the stock solution to make a sample solution.

Stock Solution: Reserpine

Prepare a stock solution of 1 $\mu\text{g}/\mu\text{L}$ reserpine in 50:50 isopropanol:water (or n-propanol:water), as follows:

1. Obtain the 1 gram vial of reserpine in your accessory kit. (The average molecular weight of reserpine is 608.7 u). Weigh out 1 mg of reserpine and transfer the sample to a polypropylene microcentrifuge tube.
2. Dissolve the reserpine sample in a total volume of 1 mL of 50:50 isopropanol:water (or n-propanol:water).
3. Ensure the sample is thoroughly dissolved in solution.
4. Label the tube *Reserpine Stock Solution (1 $\mu\text{g}/\mu\text{L}$)* and store it in a refrigerator until it is needed.

ESI / APCI Sample Solution: Reserpine

Prepare 1 mL of the sample solution of 125 $\text{fg}/\mu\text{L}$ (205 $\text{amol}/\mu\text{L}$) in 1% acetic acid in 50:50 methanol:water, as follows:

1. Pipet 100 μL of the stock solution (1 $\mu\text{g}/\mu\text{L}$) of reserpine into a clean polypropylene microcentrifuge tube.
2. Add 900 μL of 1% acetic acid in 50:50 methanol:water to the tube.
3. Mix this solution (100 $\text{ng}/\mu\text{L}$) thoroughly.
4. Transfer 10 μL of the 100 $\text{ng}/\mu\text{L}$ solution into a clean polypropylene tube.
5. Add 990 μL of 1% acetic acid in 50:50 methanol:water to the tube.
6. Mix this solution (1 $\text{ng}/\mu\text{L}$) thoroughly.
7. Transfer 10 μL of the 1 $\text{ng}/\mu\text{L}$ solution into a clean polypropylene tube.
8. Add 990 μL of 1% acetic acid in 50:50 methanol:water to the tube.
9. Mix this solution (10 $\text{pg}/\mu\text{L}$) thoroughly.
10. Transfer 100 μL of the 10 $\text{pg}/\mu\text{L}$ solution into a clean polypropylene tube.
11. Add 900 μL of 1% acetic acid in 50:50 methanol:water to the tube.
12. Mix this solution (1 $\text{pg}/\mu\text{L}$) thoroughly.
13. Transfer 100 μL of the 1 $\text{pg}/\mu\text{L}$ solution into a clean polypropylene tube.
14. Add 700 μL of 1% acetic acid in 50:50 methanol:water to the tube.
15. Mix this solution (125 $\text{fg}/\mu\text{L}$) thoroughly.

16. Label the tube *ESI / APCI Sample Solution (125 fg/μL)* and store it in a refrigerator until it is needed.

Index

A

- Accept Optimized Value dialog box (figure), 5-9
- Acquire Data dialog box
 - displaying, 5-13, 8-5
 - figure, 5-13, 8-5
 - starting acquisition from, 5-13, 8-5
 - stopping acquisition from, 5-14, 8-7
- acquiring data
 - prerequisites for, in MS/MS mode, 5-2
 - SIM scan type, 5-12, 8-4
 - using Tune Plus, 5-1, 8-1
- APCI probe
 - figure, 6-10, 8-3
 - installing, 6-10
- APCI Source dialog box
 - displaying, 7-5
 - figure, 7-5
- APCI vaporizer
 - avoiding burns from (CAUTION), 2-4, 3-23
 - disabling, 2-14
- APCI/MS
 - setting up Finnigan LTQ for, 7-5
 - using, discussion, 1-5
- API source. *See* Ion Max ion source
- AutoTune file, 3-6

B

- Breadth Focus, in Ion Tree experiment, discussion, 1-23
- buffers, discussion, 1-10

C

- caffeine
 - preparing calibration solution from, A-4
 - reordering (note), A-2
 - spectral ion from, 3-10
 - vial of stock solution
 - description, A-2
 - note, A-2
- Calibrate dialog box
 - description, 1-13
 - displaying, 3-19
 - figure, 3-19, 3-21
 - messages in Status box, 3-20
- calibration
 - discussion, 1-13
 - Finnigan LTQ setup, 3-4
 - ions, 3-10
 - procedure, 3-19
 - results (figure), 3-21
 - solutions
 - caution, 4-6
 - preparing, A-4
 - spectrum results (figure), 3-12
 - syringe pump setup for, 3-2

- capillary, ion transfer
 - temperature
 - note, 4-11
 - setting (figure), 3-6
 - voltage
 - note, 4-11
 - setting (figure), 3-6

CAUTIONS

- avoiding burns
 - from APCI vaporizer, 2-4, 3-23, 7-13
 - from ion sweep cone, 6-5
 - from ion transfer capillary, 2-8, 3-23
- avoiding contact with chemicals, A-2
- avoiding injury from corona discharge needle, 2-5, 6-6
- ensuring nitrogen flow to API source, 3-4
- exposing ion source to oxygen, 3-22, 7-13

Cautions

- avoiding contamination of system, 1-14
- calibration solution, flow rate limit of, 4-6
- solvent waste backing up into ion source housing, 2-10, 6-8, 6-11
- venting API source, 2-11, 6-9
- cleaning Finnigan LTQ, 3-22, 7-13
- collision energy
 - optimizing, 5-8
 - setting, in Define Scan dialog box (note), 5-2
- contamination
 - caution, 1-14
 - note, 3-2
 - of solvents, A-4
- corona discharge needle
 - avoiding injury from (CAUTION), 2-5, 6-6
 - figure, 2-5, 6-6
 - installing, 6-6
 - removing, 2-5

D

- data
 - acquiring, in SIM scan type, 5-12, 8-4
 - reviewing, in Qual Browser window (figure), 5-16, 8-8
- Data-Dependent Ion Tree
 - description, 1-24
 - figure, 1-23
- Define Scan dialog box
 - displaying, 3-7, 4-7, 5-12, 7-6, 8-4
 - figure, 3-7, 4-8, 5-12, 8-4
 - MS/MS settings for reserpine (figure), 5-6
- Depth Focus, discussion, 1-23
- dialog boxes
 - Accept Optimized Value, 5-9
 - Acquire Data, 5-13, 8-5
 - APCI Source, 7-5
 - Calibrate, 3-19
 - Define Scan, 3-7, 4-8, 5-3, 5-12, 8-4
 - Divert/Inject Valve, 4-10, 5-14, 8-6
 - ESI Source, 3-6, 3-16
 - Ion Optics, 3-16
 - Save As, 3-17, 4-12, 7-11

Syringe Pump, 3-9, 5-4
 Tune, 3-13, 4-10, 4-11, 7-9
 Tune, Collision Energy page, 5-7
 Divert/Inject Valve dialog box, 4-10, 5-14, 8-6
 divert/inject valve, loop injection (figure), 5-11, 8-2

E

ESI probe
 figure, 2-13
 installed (figure), 6-2
 installing, 2-12
 ESI Source dialog box
 displaying, 3-6, 3-10
 figure, 3-6, 3-16
 viewing parameters, 3-14
 ESI/MS
 defining scan parameters, 3-7
 discussion, 1-4
 operational guidelines (table), 1-11
 optimizing Tune Method, 4-1
 preparing calibration solution for, A-4
 setting up Finnigan LTQ for, 4-6
 testing Finnigan LTQ, 3-9
 experiment types
 Data-Dependent, 1-18
 discussion, 1-16
 General MS, 1-16
 Ion Mapping, 1-20
 Ion Tree, 1-23

F

Figures
 Accept Optimized Value dialog box, 5-9
 Acquire Data dialog box, 5-13, 8-5
 APCI plumbing for Tee, 7-3
 APCI probe, 6-10, 8-3
 APCI probe installation, 2-3
 APCI Source dialog box, 7-5
 Calibrate dialog box, 3-19
 calibration solution spectrum display, 3-12
 corona discharge needle, 6-6
 Define Scan dialog box, 3-7, 4-8, 5-12, 8-4
 MS/MS Full scan settings, 5-3
 MS/MS settings for reserpine, 5-6
 Divert/Inject Valve dialog box, 4-10, 5-14, 8-6
 divert/inject valve, positions for loop injection, 5-11, 8-2
 ESI probe, 2-13
 ESI Source dialog box, 3-6, 3-16
 experiment templates
 General MS, 1-17
 Ion Tree, 1-23
 Total Ion Map, 1-21
 Triple Play, 1-19
 Ion Max ion source
 connections of, 2-12
 detail of components, 2-4, 2-9, 6-4, 6-7
 ESI probe installed, 2-14, 6-2
 installing, 2-6
 Ion Optics dialog box, 3-16

ion source mount, 2-10, 6-8
 ion sweep cone, 2-8
 loop injection of reserpine, 5-15
 MS/MS spectrum of reserpine, 5-9
 plumbing
 loop injection, 5-10
 syringe pump, 3-2, 3-3
 Tee union, 4-4
 Qual Browser window, 5-16, 8-8
 Save As dialog box, 3-17, 4-12, 7-11
 spectral results of loop injection, 8-6
 sweep gas supply port, 2-7
 Syringe Pump dialog box, 3-9, 5-4
 Tune dialog box
 Collision Energy page, 5-7
 settings for automatic tuning, 3-13, 4-10, 7-9
 Tune Plus window
 automatic calibration results, 3-21
 Automatic page, Tune dialog box, 4-11, 7-9
 results of automatic tune, 3-16
 Wideband Activation check box, 5-3
 Finnigan LTQ
 calibrating, 3-19
 cleaning for normal operation, 3-22, 7-13
 discussion, 1-2
 ESI/MS mode, testing, 3-9
 flow rates, discussion, 1-11
 introducing sample
 discussion, 1-8
 table, 1-9
 operational guidelines (table), 1-11
 optimizing Tune Method, LC/ESI/MS operation, 4-1
 placing in Standby, 2-2
 setting up for APCI/MS operation, 7-5
 setting up for ESI/MS operation, 4-6
 flow rates
 discussion, 1-11
 effects of (note), 3-10
 note, 4-11

G

Graph view
 displaying, 3-15, 4-9, 7-8
 freezing, 3-22, 7-13
 observing, 3-20
 guidelines
 LC/APCI/MS operational (table), 1-12
 LC/ESI/MS operational (table), 1-12

H

Home Page. See Xcalibur

I

Instrument Setup window
 description, 1-16
 displaying, 2-2, 3-4
 introducing samples into Finnigan LTQ, discussion, 1-8

Finnigan LTQ

- Ion Max ion source
 - components (figure), 2-4, 6-4
 - connections (figure), 2-12
 - discussion, 1-4
 - ensuring nitrogen flow to (CAUTION), 3-4
 - ESI probe installed (figure), 2-14
 - exposing to atmosphere (CAUTION), 3-22, 7-13
 - figure, 2-9, 6-7
 - installing, 6-7
 - installing (figure), 2-6
 - removing, 2-6, 6-4
- Ion Optics dialog box
 - displaying, 3-14
 - optimized tune (figure), 3-16
- ion source mount (figure), 2-10, 6-8
- ion sweep cone
 - avoiding burns from (CAUTION), 6-5
 - description, 2-7
 - figure, 2-8
 - installing, 2-7
 - removing, 6-5
- ion transfer capillary
 - affecting signal quality (note), 1-14
 - avoiding burns from (CAUTION), 2-8, 3-23, 6-5
 - cleaning, 3-23
 - discussion, 1-11, 4-1
 - flushing, 3-24
 - gaining access to, 3-22
 - optimizing temperature of
 - discussion, 7-1, 7-8
 - note, 3-10, 4-11
 - reinstalling, 3-23
 - removing, 3-23
 - sealing, 3-23
 - temperature guidelines
 - APCI operation, 1-12
 - ESI operation, 1-12
 - unsealing, 3-24
- Ion Tree experiment
 - Breadth Focus, 1-23
 - Depth Focus, 1-23
- isolation width
 - note, 5-5
 - optimizing, 5-2

L

- loop injection
 - reserpine results (figure), 5-15, 8-6
 - setup for, 5-10, 8-2

M

- methods, Tune. See Tune Methods
- MRFA
 - preparing calibration solution from, A-4
 - preparing stock solution of, A-2
 - reordering (note), A-2
 - spectral ion from, 3-10
 - vial of stock solution (note), A-2

- MS Detector Setup page
 - General MS experiment, figure, 1-17
 - Triple Play experiment, figure, 1-19
- MS detector. See Finnigan LTQ
- MS/MS
 - acquiring, data, 5-2
 - discussion, 1-3

N

- needles
 - corona. See corona discharge needle
 - syringe. See syringes
- nitrogen
 - atomic, affect on ion current, 1-5
 - sweep gas
 - discussion, 1-7
 - ensure flow to API source (CAUTION), 3-4
 - starting flow of, 3-5
- Normalized Collision Energy parameter, 5-2
- Notes
 - acquire data without optimizing, 4-1
 - additional reference material, 2-3
 - collision energy, 5-2
 - cutting PEEK tubing, 7-3
 - effect of flow rates, 3-10
 - ensuring that Finnigan LTQ is set up, tuned, and calibrated, 4-2
 - ESI signal quality, 1-14
 - ESI tune files, 3-6
 - ion transfer capillary temperature, 4-11
 - optimizing isolation width, 5-5
 - optimizing Tune Method, 3-14
 - saving Tune Method, 3-17, 4-12, 7-11
 - solution flow rate, 4-11
 - solvents, 3-23, 7-14
 - syringes, Unimetrics, 3-9, 5-3
 - tube lens voltage, 4-11
 - Unimetrics syringe, 3-9, 5-3
 - using glass pipettes or stainless steel syringes with glacial acetic acid, A-4
 - vials of stock solutions, A-2

O

- optimizing
 - auxiliary gas, 1-7
 - collision energy, 5-8
 - automatically, 5-6, 5-8
 - discussion, 5-2
 - note, 5-2
 - saving value, 5-8
- Finnigan LTQ
 - automatically, 3-4
 - discussion, 1-13
 - for LC/ESI/MS operation, 4-1
 - ion transfer capillary temperature, 3-13
 - isolation width, 5-2
 - discussion, 5-2
 - note, 5-5
 - performance of data acquisition, discussion, 1-13

pH of solvent, 1-5
sweep gas, 1-7
Tune Method
 automatically, 4-9
 automatically (figure), 3-16
 discussion, 3-14, 4-1
 note, 3-14, 4-2

P

PEEK tubing, cutting (note), 7-3
pipettes, using glass, with glacial acetic acid (note), A-4
plumbing
 divert/inject valve (figure), 5-10
 loop injection (figure), 5-10
 syringe pump (figure), 3-2, 3-3
 syringe pump, Tee to LC (figure), 4-4
procedures
 acquiring data
 SIM scan type, 5-12, 8-4
 using Tune Plus, 5-1, 8-1
 calibrating Finnigan LTQ automatically, 3-19
 cleaning Finnigan LTQ after tuning and calibrating,
 3-22, 7-13
 installing
 APCI probe, 6-10
 corona discharge needle, 6-6
 ESI probe, 2-12
 Ion Max ion source, 6-7
 ion sweep cone, 2-7
 optimizing
 APCI tune, 7-8
 collision energy, 5-8
 ESI tune, 4-9
 isolation width, 5-2
 preparing
 calibration solutions, A-4
 MRFA stock solutions, A-2
 reserpine sample solutions, A-5
 Ultramark 1621 stock solution, A-3
 removing
 APCI probe, 2-3
 ESI probe, 6-2
 ion sweep cone, 6-5
 saving Tune Method, 3-17, 4-12, 7-11
 setting up
 Finnigan LTQ analyzing your analyte, 4-6
 Finnigan LTQ for APCI/MS operation, 7-5
 hardware for tuning and calibrating, 2-1
 loop injection, 5-10, 8-2
 syringe pump, 3-2, 4-3
 stopping LC flow, 6-2
 testing Finnigan LTQ in ESI/MS mode, 3-9
 tuning and calibrating
 Finnigan LTQ, 3-1
 setting up for, 3-4
 tuning Finnigan LTQ automatically
 in APCI/MS mode, 7-8
 in ESI/MS mode, 3-13
 using your analyte, 4-1

Q

Qual Browser window (figure), 5-16, 8-8
quantitation experiments, 1-16

R

reserpine
 acquiring, data, loop injection, 5-1, 8-1
 MS/MS settings for, in Define Scan dialog box (figure),
 5-6
 MS/MS spectrum (figure), 5-9
 preparing ESI sample solution, A-5
 preparing solutions of, A-5

S

sample solutions, reserpine, preparing, A-5
Save As dialog box
 displaying, 3-17, 4-12, 7-11
 figure, 3-17, 4-12, 7-11
saving, Tune Method
 figure, 3-17, 4-12, 7-11
 note, 3-17, 4-12, 7-11
scan parameters, defining (figure), 3-7
sheath gas flow rate (figure), 3-6
signal quality, ESI (note), 1-14
SIM scan type, acquiring data in, 5-12, 8-4
solutions, preparing
 calibration, A-4
 reserpine, A-5
solvents (note), 3-23, 7-14
Standby, placing Finnigan LTQ in, 2-2
sweep gas supply port (figure), 2-7
syringe pump
 description, 1-8
 installing syringe into, 3-2, 4-3, 7-2
 locating, 3-2
 plumbing, 4-3, 7-2, 7-4
 plumbing (figure), 7-2
 removing syringe from, 3-22, 7-13
 setting up for tuning and calibrating, 3-2
 starting, 3-9, 3-14, 4-9, 5-3, 7-8
 stopping, 3-22, 5-8, 7-13
 using, 1-13, 1-14
Syringe Pump dialog box
 displaying, 5-4
 figure, 3-9, 5-4
syringes
 note, 3-9, 5-3
 use stainless steel, with glacial acetic acid (note), A-4

T

Tables
 ESI operational guidelines, 1-11
 sample introduction techniques, 1-9
Tee union, plumbing (figure), 4-4
Total Ion Map page, figure, 1-21

Finnigan LTQ

tube lens
 setting (figure), 3-6
 voltage (note), 4-11

Tune dialog box
 Automatic page, 4-11
 Collision Energy page (figure), 5-7
 figure, 3-13, 4-10, 7-9
 showing settings for automatic tuning (figure), 3-13, 4-10, 7-9

Tune Methods
 opening predefined, 3-6, 4-6, 7-5
 saving (note), 3-17, 4-12, 7-11

Tune Plus window
 additional reference material (note), 2-3
 loop injection (figure), 5-15, 8-6
 MS/MS spectrum (figure), 5-9
 opening, 2-2, 3-4, 4-6
 placing Finnigan LTQ in Standby from, 2-2
 showing automatic tune optimization (figure), 3-16
 showing calibration results (figure), 3-21
 tuning results (figure), 3-16, 4-11, 7-9
 using, to acquire data, 5-1, 8-1

tuning
 automatically, 3-13
 discussion, 1-13
 ESI tune files (note), 3-6
 Finnigan LTQ
 for LC/ESI/MS operation, 4-1
 note, 3-14
 setup for, 3-4, 4-6
 syringe pump, setup for, 3-2
 voltages, 3-13

U

Ultramark 1621
 cleaning spray shield of, 3-24
 contamination from (caution), 1-14, 4-6
 preparing calibration solution from, A-4
 preparing stock solution of, A-3
 reordering (note), A-2
 spectral ions from, 3-10
 vial of stock solution (note), A-2

Unimetrics, syringes. *See* syringes

V

voltages
 automatic optimization, description, 3-1, 4-1
 optimized tune (figure), 3-16
 settings displayed in Ion Optics dialog box (figure), 3-16

W

Wideband Activation
 discussion, 1-3
 option (figure), 5-3

X

Xcalibur
 displaying Home Page, 2-2, 3-4, 4-6
 displaying Roadmap view, 4-6

Z

ZoomScan, discussion, 1-4, 1-20

